

Jump beta

Sport and BSA frames



Instructions for use

Imprint

SORG Rollstuhltechnik GmbH + Co. KG
Benzstrasse 3-5
68794 Oberhausen-Rheinhausen / Germany

Phone +49 7254-9279-0
Fax +49 7254-9279-10
E-Mail info@sorgrollstuhltechnik.de
Web www.sorgrollstuhltechnik.de

Revision status

2023-09-19

Technical status

Technical changes and misprints reserved. The pictures in this Instructions for use can differ from the actual equipment components. However, a corresponding conduction is possible.

Copyright

All texts, pictures and graphics underlie copyright protection. All rights, including copying, publishing, editing and translating, remain reserved. © by SORG Rollstuhltechnik GmbH+Co. KG Benzstraße 3-5, 68794 Oberhausen-Rheinhausen / Germany.

 Our terms and conditions can be found on our order forms and at www.sorgrollstuhltechnik.de/impressum

1 Wheelchair overview	5	3.9 Handling anti-tipper	38
		3.9.1 General information regarding anti-tipper	38
2 General information	6	3.10 Handling headrest	39
2.1 Preface	6	3.10.1 General information regarding headrest	39
2.2 General information regarding instructions for use	6	3.11 Handling abduction wedge	40
2.2.1 Signs and Symbols	7	3.11.1 General information regarding abduction wedge	40
2.2.2 Intended purpose	8	3.12 Handling therapy table	41
2.2.3 Indication	8	3.12.1 General information regarding therapy table	41
2.2.4 Contraindication	8	3.13 Handling lateral truss pad	41
2.3 General safety information	9	3.13.1 General information regarding lateral truss pad	41
2.3.1 Loading and transport without occupants	11	3.14 Handling steering & pushing aid	42
2.3.2 Transport of the wheelchair with passengers in a motor vehicle	11	3.14.1 General information regarding steering and pushing aids	42
2.3.3 Other important information	13	3.15 Handling one-hand steering aid	43
		3.15.1 General information regarding one-hand steering aid	43
3 Handling	15	3.16 Handling sun shade	45
3.1 Handling driving wheel	15	3.16.1 General information regarding sun shade	45
3.1.1 General information regarding wheels	15		
3.1.2 Tyre inflation pressure	15	4 Repairs/maintenance/reinstatement	46
3.1.3 Quick-release axles	15	4.1 Repairs	46
3.1.4 Double hand rim-wheels	16	4.2 Spare parts	46
3.2 Handling swivel caster	17	4.3 Maintenance	46
3.2.1 General information regarding swivel casters	17	4.4 Disinfection	46
3.2.2 Caster track lock	17	4.5 Storage	46
3.3 Handling seat and back	18	4.6 Lifespan	47
3.3.1 General information regarding back	18	4.7 Reinstatement	47
3.3.2 Fixed seat plate (SeatFix)	18	4.8 Disposal	47
3.3.3 Fixed seat plate with locking mechanism (SeatFix)	19	4.9 Maintenance/Inspection	47
3.3.4 Firm curved back plate	20		
3.3.5 Back with raster	21	5 Technical data	49
3.3.6 Back with gas pressure spring	22	5.1 Data and measurements	49
3.3.7 Back extension	22	5.2 Meaning of labels	50
3.4 Handling side guard	23	5.3 Declaration of conformity	50
3.4.1 General information regarding side guard	23		
3.4.2 Arm rests	23	6 Verification of yearly inspection	51
3.5 Handling folding up and unfolding	24		
3.5.1 General information regarding folding up and unfolding	24		
3.5.2 of seat and back cover	25		
3.5.3 of SeatFix and/or firm curved back plate	26		
3.6 Handling pushing aid	27		
3.6.1 General information regarding pushing aids	27		
3.6.2 Push handles	28		
3.6.3 Handle bar	29		
3.7 Handling leg support	30		
3.7.1 General information regarding leg supports	30		
3.7.2 Foldable footrest with locking mechanism	31		
3.7.3 Detachable and swivelling leg support (Jump beta BSA)	32		
3.8 Handling brake	35		
3.8.1 General information regarding brakes	35		
3.8.2 Wheel lock	35		
3.8.4 Reverse-roll locking	37		
3.8.3 Drum brake	37		

1 Wheelchair overview

Jump beta overview - Frame variant Sport

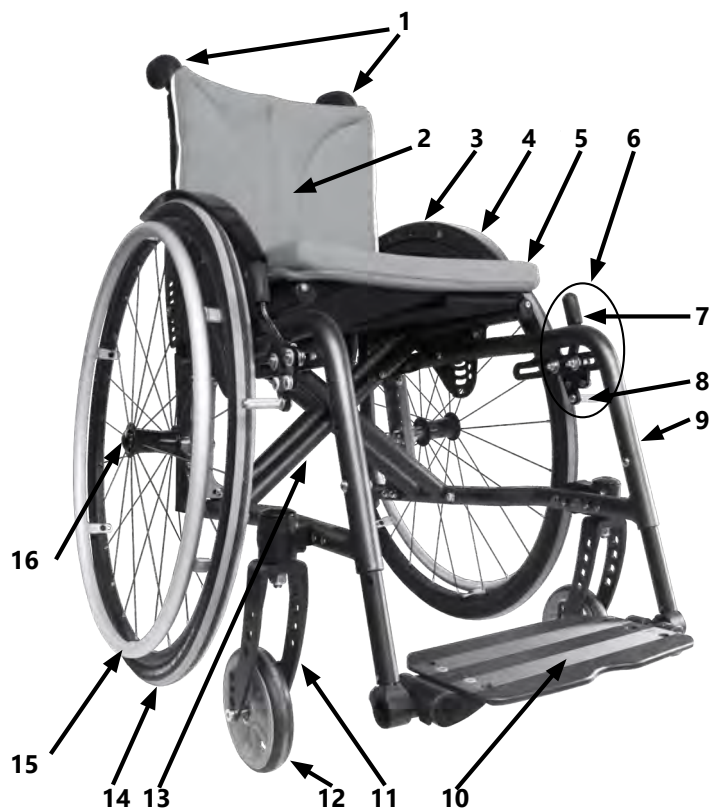

- 1 Push handles
- 2 Back
- 3 Side guard
- 4 Clothes guard
- 5 Seat cushion
- 6 Wheel lock (knee lever brake)
- 7 Brake lever
- 8 Brake bolt
- 9 Frame variant Sport with integrated leg support
- 10 Foot plate (continuous)
- 11 Caster fork
- 12 Swivel caster
- 13 Crossbrace
- 14 Driving wheel
- 15 Handrim
- 16 Quick-release axle

Jump beta overview - Frame variant BSA

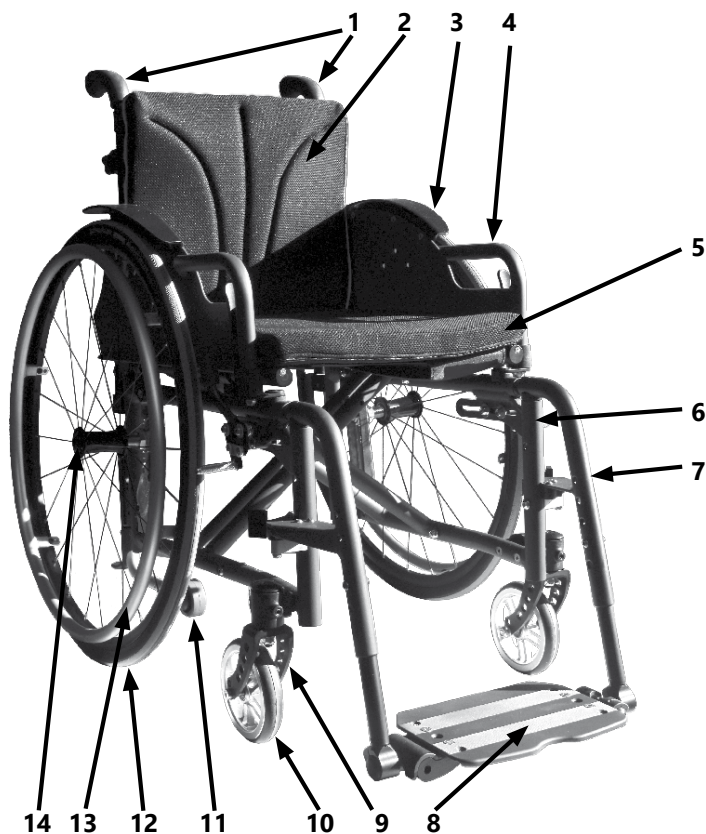

- 1 Push handles
- 2 Back
- 3 Clothes guard
- 4 Desk side guard
- 5 Seat cushion
- 6 Wheel lock (knee lever brake)
- 7 Frame variant BSA
- 8 Foot plate (continuous)
- 9 Caster fork
- 10 Swivel caster
- 11 Anti-tipper
- 12 Driving wheel
- 13 Handrim
- 14 Quick-release axle

2.1 Preface

A warm welcome to the SORG family – many thanks for the trust you have placed in us and for choosing our product.

This wheelchair has been individually tailored to meet your specific requirements.



You will find the usage and adjustment instructions below so that you can use the wheelchair in everyday life without tools. Please observe these instructions and handle the wheelchair carefully so that you can enjoy it for as long as possible.

Please do not hesitate to contact us if you have any questions about this or any other product.

We hope you enjoy using your SORG product.

Your SORG team

2.2 General information regarding instructions for use

These instructions for use contain safety information and handling instructions that are necessary for the correct use of the product.

All settings, adjustments and repairs beyond the scope of these instructions for use, and the annual inspection, must be carried out by a qualified specialist dealer.

You can find more information about this in our service record, which can be accessed at www.sorgrollstuhltechnik.de

The user and specialist dealer must have read and understood these instructions before commissioning. These instructions for use cover all equipment variants of the product. Have your consultant instruct you on the safe handling of the wheelchair and your individual equipment variants on level ground and with the support of an accompanying person.

 Those with impaired vision can find these instructions for use on our website www.sorgrollstuhltechnik.de as PDF and audio files.

Please contact your specialist dealer or our team if you have any questions or comments (+49 7254 9279-0).

Keep these instructions for use in a safe place. All annual inspections carried out must be documented by the specialist dealer.

2 General information

2.2.1 Signs and Symbols



ATTENTION! Warnings for personal Safety aspects that are of the utmost importance.



CORRECT safety adjustment/ use



INCORRECT adjustment /use



NOT ALLOWED



References to additional/ continuing reading.



important detail



correct or proper use/setting



incorrect or improper use/setting

(A); (B)

reference from text to detail

USE



push/ pull/ insert/ move/ remove



Push in specific direction



Setting or adjusting the angle



open/close



Turn clockwise



Turn counterclockwise



steps to be done at the same time

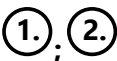

steps to be done after each other



Steps to be taken on both sides



View

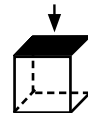

view from top

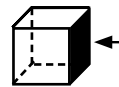

view from the side



view from the bottom

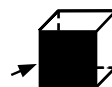

view from the front

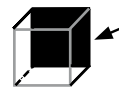

view from the back



fasten parts



remove parts

2.2.2 Intended purpose

The Jump beta is a light and manoeuvrable active wheelchair designed for indoor and outdoor use.

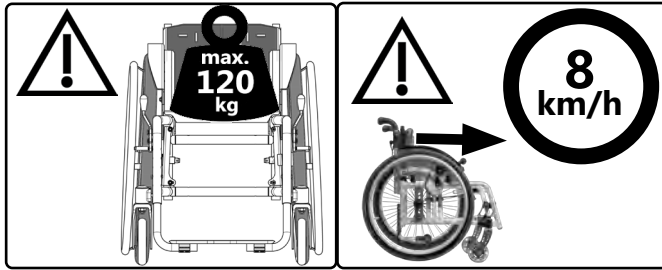

The wheelchair is designed solely for the transport of the person for whom it has been specially adapted by a qualified specialist dealer.

Parents or authorised guardians must ensure that the information in the instructions for use is followed for children or persons with impaired capacities.

The safest possible use of the aid is only possible on level, firm and dry ground with the anti-tipper activated and with the help of an accompanying person.

Any use beyond this entails taking a variety of risks for which only the user themselves can take responsibility. This requires sufficient competence in identifying and avoiding hazards and safe handling of the aid by the user! An increased hazard potential must be taken into account, especially in wet conditions, ice, loose ground, slopes, obstacles, close proximity to water, road traffic, narrow spaces, etc.

Only use the wheelchair for its intended purpose. Any improper use of the product involves considerable risks and will invalidate product liability.

The large variety of combinations for seat and wheel position means that settings can be made that are outside the safety and application range.

2.2.3 Indication

Use is suitable for the following functional impairments, among others:

- (infantile) cerebral palsy,
- spina bifida,
- paralysis,
- multiple sclerosis,
- muscle disorders,
- impairments of the lower extremities,
- cardiovascular insufficiency,
- rheumatic disorders.

2.2.4 Contraindication

Use is unsuitable for:

- serious tonus dysregulation (spasms etc.)

Active use is unsuitable for:

- cases of extremely restricted perception or impaired competence to act (active engagement in road traffic without an accompanying person is **not** possible).

We accept **no** liability for damage to persons or objects resulting from the circumstances described above.

2 General information

2.3 General safety information

Before each use, check:

- the frame, back tubes, add-on parts and accessories for visible damage, bending, cracks or missing or loose screws,
- the wheels and quick-release axles for tightness,
- that the inflation pressure and tyre tread are sufficient,
- that the brakes are working properly,
- that the angle adjustment elements/ eccentric clamps are secure,
- that the seat plate/ back/ footrest are tightly locked,
- that the anti-tipper/seat and back belts are functioning correctly,
- that all previously dismantled components have been reconnected and firmly locked.

There is a risk of injury (e.g. due to crushing) from all rotating, swivelling or foldable components, even during adjustment and repair work and during transport.

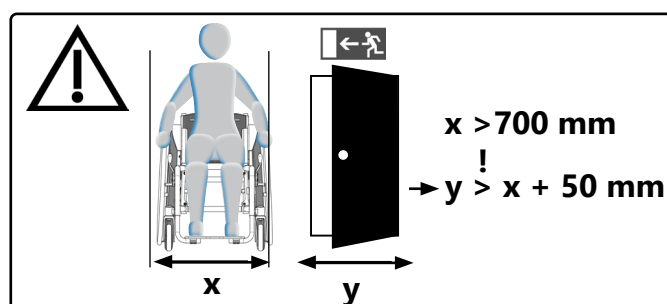
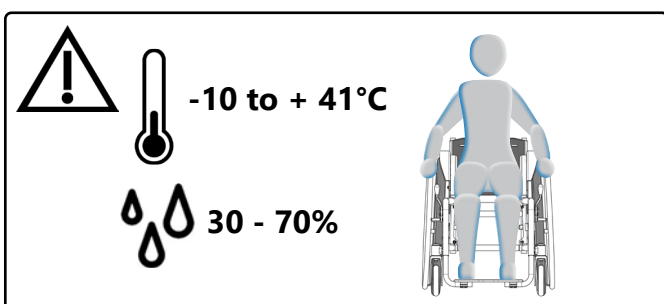

Danger of tipping over and overturning

Occupants must only get in and out of the wheelchair with the wheel lock and anti-tipper engaged.

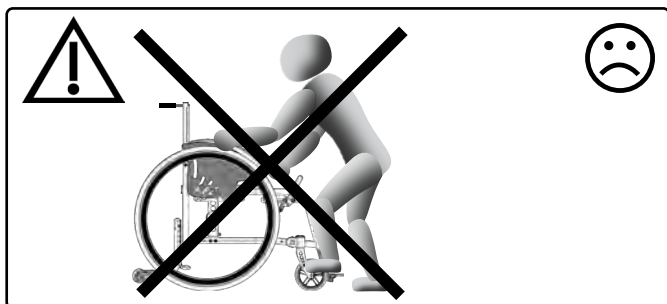

Do not use the footrest(s) for getting in and out of the wheelchair. The wheelchair might tilt forward.

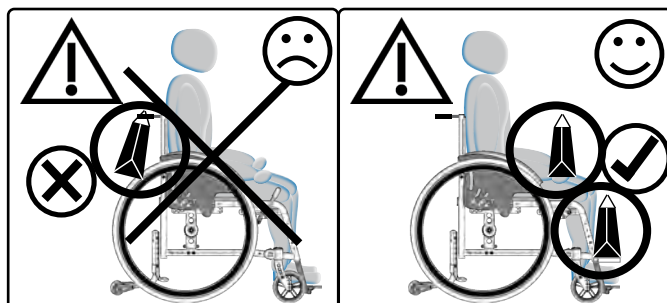

The risks listed as examples below may occur when dismantling the following parts/ accessories:

- Cushions: lack of hygiene / pressure points
- Headrest: loss or missing headrest during transport
- Driving wheels: loss of the back (use of wheelchair not possible)

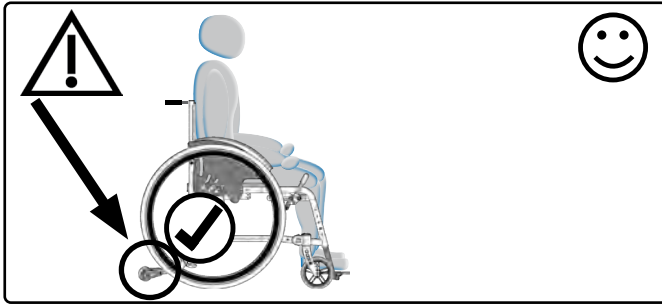

⚠ We strongly recommend the use of the anti-tipper.

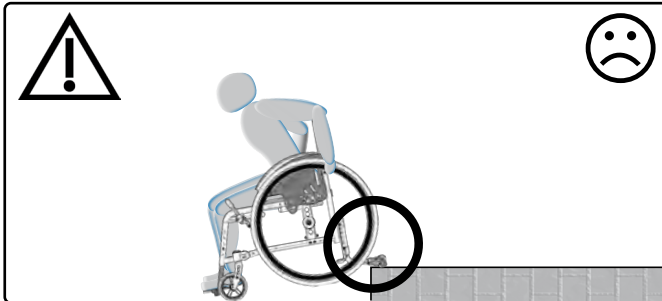

⚠ The anti-tipper must be deactivated when moving down over edges.

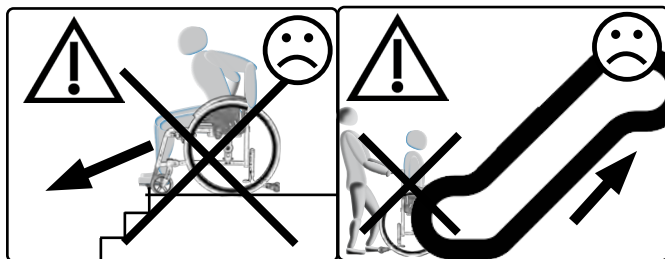
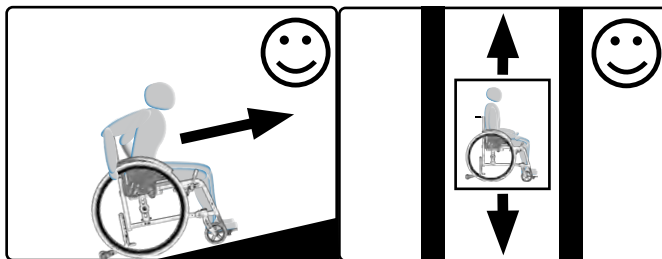

⚠ Only negotiate stairs with the help of experienced assistants. The anti-tipper must be deactivated when doing so. The wheelchair must always be carried by the **frame only, never** by the seat shell, the extendable push handle(s), push bail, handle bar, leg supports and/or the footrest(s)!

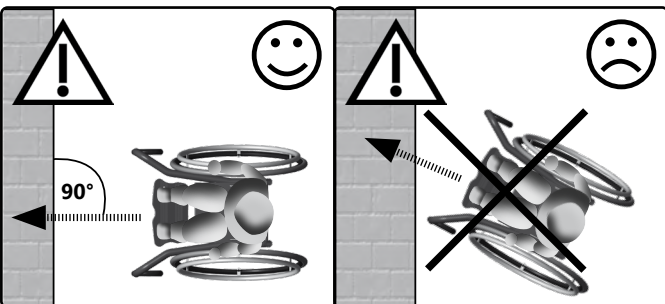
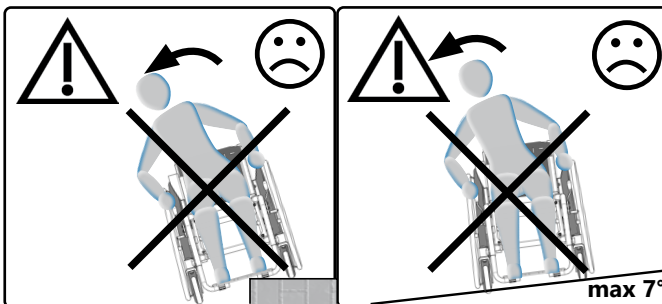

Inclines, downward gradients and obstacles

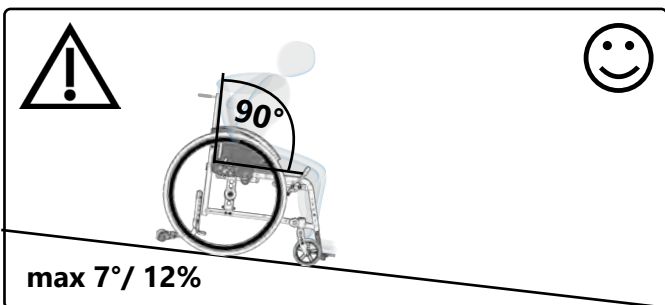
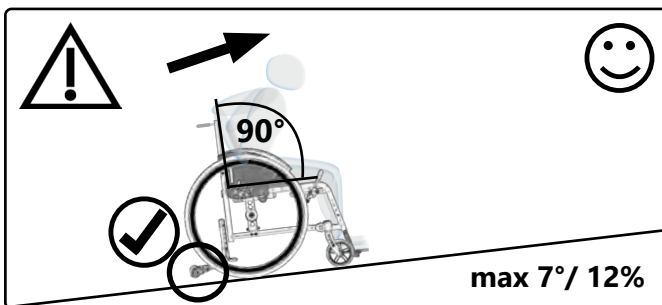

2.3.1 Loading and transport without occupants

Make sure that the packing size you require is suitable and secure the wheelchair and all dismantled components with sufficient load securing. The wheelchair is suitable for transport (land/air) in principle. Inform yourself about suitable load securing precautions before wheelchair transport.

Carrying points:

- Seat tubes when folded
- Frame tubes, front l/r
- Frame tubes, rear l/r
- But **not** on the detachable leg supports and/or footrests.

2.3.2 Transport of the wheelchair with passengers in a motor vehicle

 The characteristics of wheelchairs mean that they can never achieve the stable properties of a fixed seating system in a vehicle. Wherever possible, we recommend using a fixed vehicle seat to transport a person in a motor vehicle.

 Only wheelchairs that have successfully passed a crash test in accordance with ISO 7176-19 may be used as seats in motor vehicles. Successfully tested wheelchairs are provided with the symbol for the attachment point on the affixed nameplate.



The Jump beta in the Sport and BSA variants has been successfully tested in accordance with ISO 7176-19 and is therefore approved for use as a seat in a motor vehicle provided that it is fitted with the necessary restraint systems.



 Please check whether your wheelchair is custom-made because it may not be suitable for use as a seat in a motor vehicle. If this is the case, the symbol for the attachment point will be missing from the nameplate and the wheelchair will be marked with a warning, represented by the crossed-out symbol for the attachment point.



 More information can be found in the crash test brochure at www.sorgrollstuhltechnik.de/downloadportal.

We can recommend the following manufacturers of restraint systems:

- SORG restraining eyelets on wheelchairs
- AMF-BRUNS GmbH & Co.KG
- Q'Straint Europe

Attachment points/methods for transport in motor vehicles

When using the wheelchair as a seat in a motor vehicle, only the positions marked with the symbol for the attachment point should be used. These can usually be found at the back left and right **(1)** and at the front left and right. **(2)**

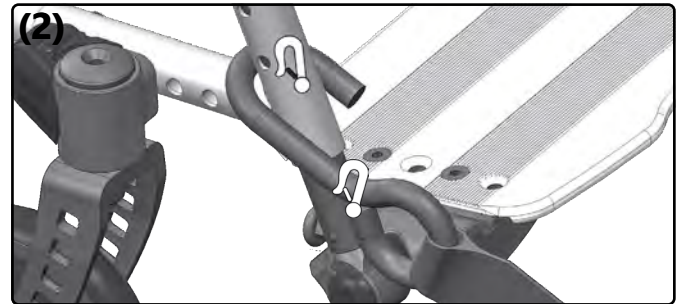
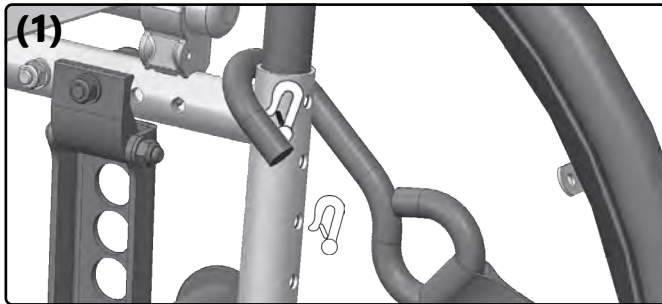

The wheelchair must be fixed with a 4-point wheelchair restraint system anchored to the vehicle in accordance with ISO 10542. These may be carabiner hooks, S-shaped hooks or plug-in fasteners. The wheelchair restraint system must be securely fastened and used in accordance with the user manual of the manufacturer. **(3A+B)**

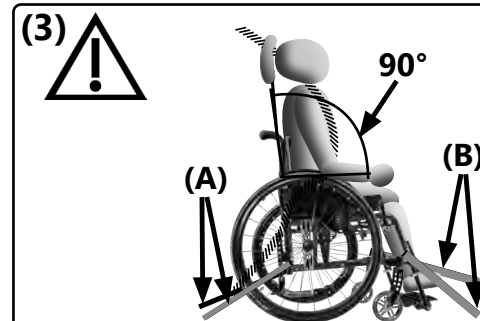

If the wheelchair is equipped with a back angle-adjustment or tilt mechanism, the occupant must sit in an upright position at a 90° back angle during transport **(3)**. Leg supports that can be swung up must be adjusted to the lowest position.

The user must be additionally secured with a fixed lap belt **(4C)** approved for transport in accordance with ISO 10542 and a vehicle-anchored shoulder belt **(4D)** so that the risk of head and upper body injuries can be minimised to the greatest extent possible.

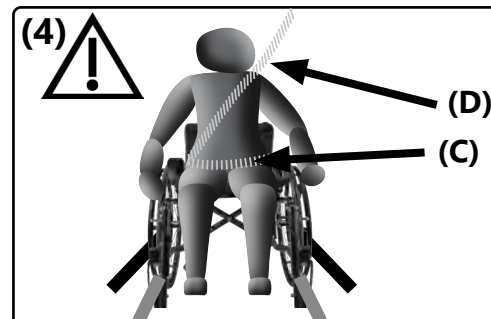

The seat belts must not be twisted during use, nor must they be guided over any structural components, which would keep them away from the body. They have to be tight and firm without impairing user comfort. The lap belt buckle must be positioned between the pelvic bones (if possible in the middle). The buckle tongues on the lap belt for fastening the shoulder belt should be located on the outside of the pelvis where possible.

All belts used for transport must be regularly inspected for damage.

A headrest suitable for transport must be used.

The wheelchair must only be used as a forward facing seat in motor vehicles in accordance with ISO 7176-19. No transport with the wheelchair facing sideways!

Immediately contact your authorised dealer after a collision to check the carriage, frame and brakes and have any damage repaired by a specialist without delay.

 Any braking devices fitted to the wheelchair must be in the braked position when the wheelchair is transported in a motor vehicle.

2.3.3 Other important information

 The seat shell-underframe has been tested and verified for resistance to ignition of textile materials in compliance with the applicable standards. Nevertheless, there is a risk of ignition of the flame-retardant textile components. Keep any sources of ignition away from the wheelchair.

 The wheelchair must neither be exposed to excessive moisture nor come into contact with salt water.

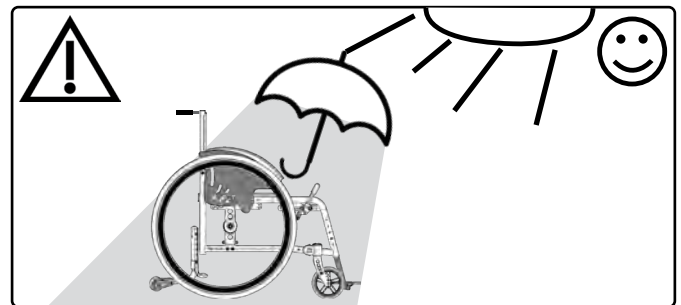
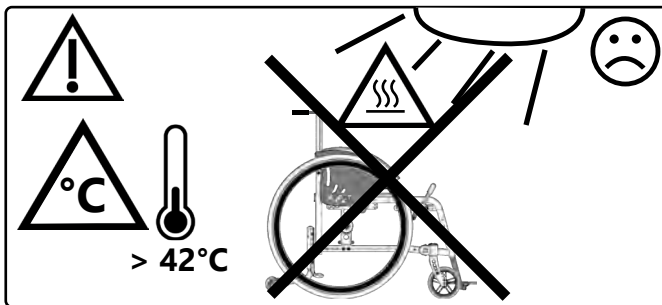

When configuring the wheelchair, pelvic restraints (lap belts as positioning aids) can be optionally purchased via the SORG order sheets or by ordering from the replacement parts catalogues. Your specialist dealer will carry out the assembly.

The product may interact with electromagnetic fields (e.g. shop anti-theft devices) in individual cases. This poses no danger to the user and/or the attendant.

The wide variety of settings available means that not all limit values can be complied with in all possible configurations in accordance with the *Regulation (EU) on the technical specifications for interoperability relating to accessibility of the Union's rail system for persons with disabilities and persons with reduced mobility*.

Please contact your specialist dealer or us as the manufacturer if you experience any issues with the wheelchair. Product recalls etc. will be published on our website www.sorgrollstuhltechnik.de. You can also find the respective contact persons there.

Corrosion protection

The product has been designed with corrosion protection in mind when selecting the materials (e.g. plastic, aluminium, stainless steel). All materials prone to corrosion are surface-treated and are therefore protected.

The wheelchair must be dried thoroughly if it becomes wet.

Lifespan

 Use beyond the specified lifespan increases the residual risks and should only be carried out after careful, qualified consideration by the operator. If the useful life is reached, the user or a responsible person should contact the specialist dealer. There you can be informed about the possibility of reprocessing the product.

Combination with products from other manufacturers

 The wheelchair may only be combined with the electrical auxiliary drives approved by the manufacturer. The responsibility of restrictions or adjustments as well as the attachment itself lies with the supplier of the additional system or the specialized retailer. Please ask about the conditions with the manufacturer of the auxiliary drives.

 In combination of wheelchair and electric auxiliary drive, certain strains occur that can lead to damage to the wheelchair. Slowly approach obstacles and carefully overcome them so that little force is applied to the casters, rear wheels and the wheelchair as a whole.

3.1 Handling driving wheel

3.1.1 General information regarding wheels

Frictional heat is generated by braking the wheels on the handdrims.

Handrim covers can stretch when exposed to heat and become detached from the handrim.

3.1.2 Tyre inflation pressure

You can find the right operating pressure on the tyre casing – usually 3-10 bar. **(1)**

If the tyre is flat, please contact your specialist dealer.



3.1.3 Quick-release axles

Remove:

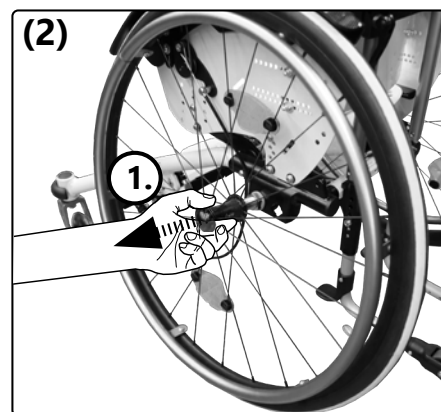
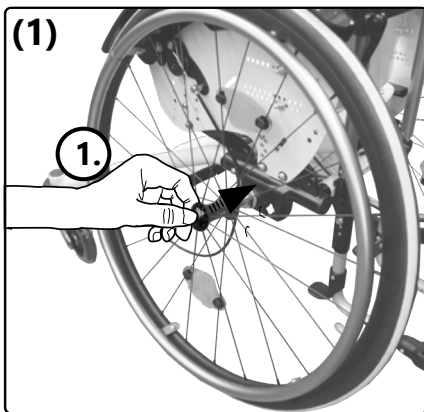

Insert:

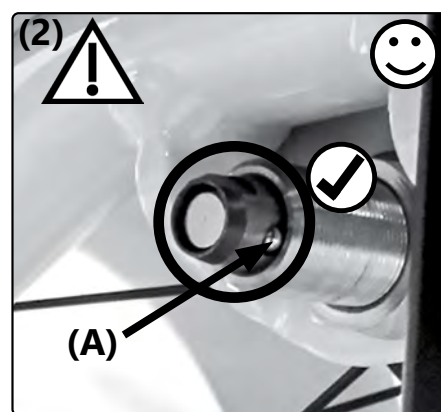
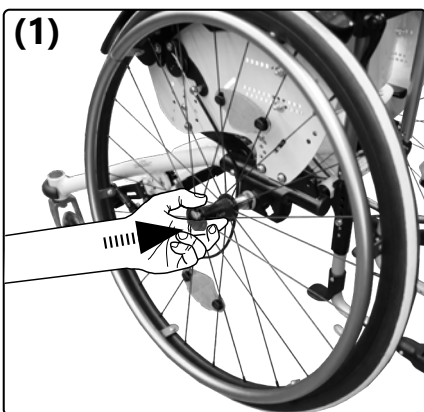

(2) After insertion, the locking ball **(A)** must be visibly protruding. Pull at least 1x after each insertion to test whether the quick-release axle is engaged. It should no longer be possible to pull the wheels outwards.

3.1 Handling driving wheel

3.1.4 Double hand rim-wheels

Insert:

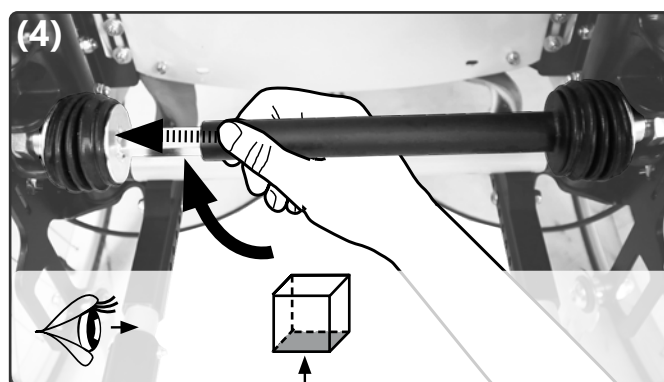
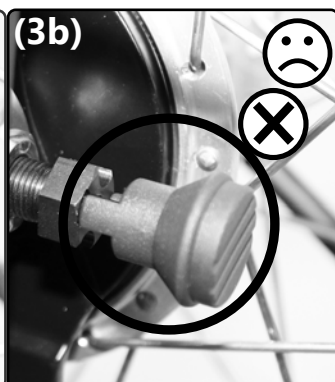
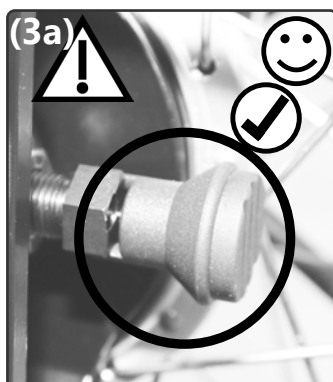
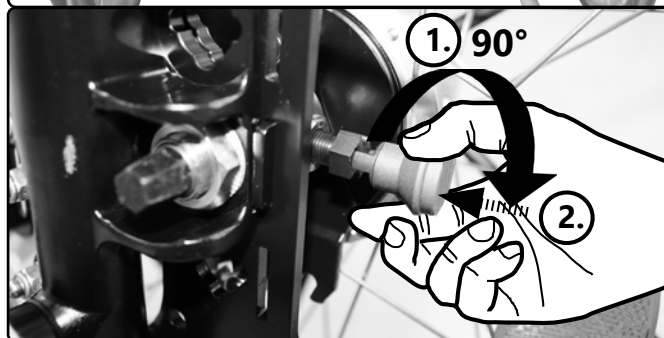
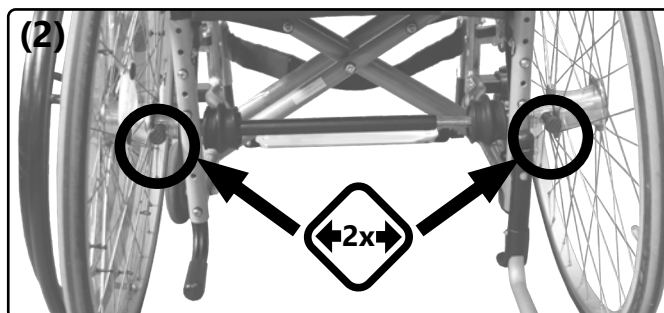
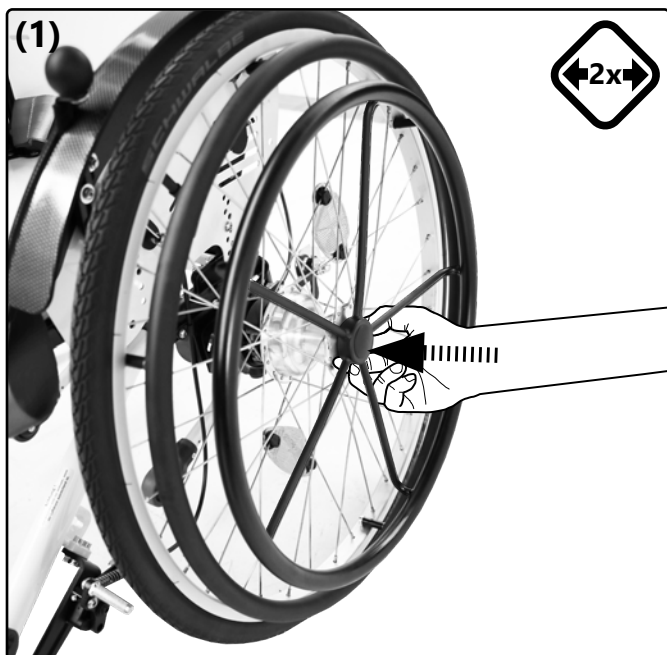

Remove: Proceed accordingly in reverse order

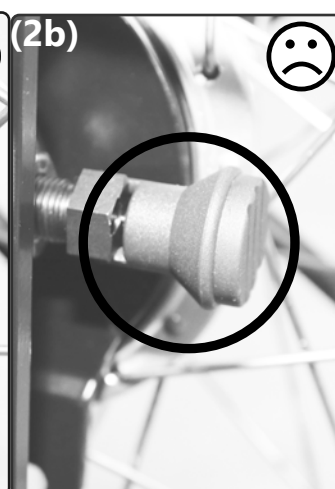
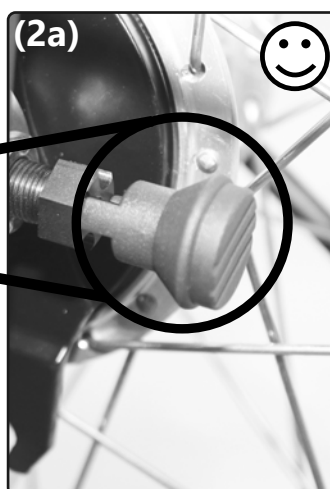

3.2 Handling swivel caster

3.2.1 General information regarding swivel casters

Incorrectly adjusted swivel casters or excessive speed can cause the casters to flutter. Immediately slow down at the first sign of fluttering and have the swivel casters readjusted by a specialist dealer.

3.2.2 Caster track lock

Unlock:

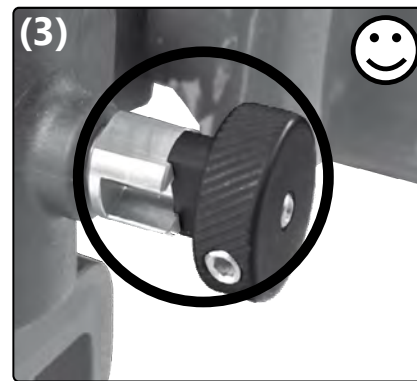
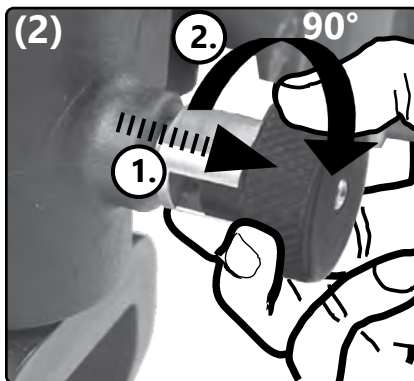
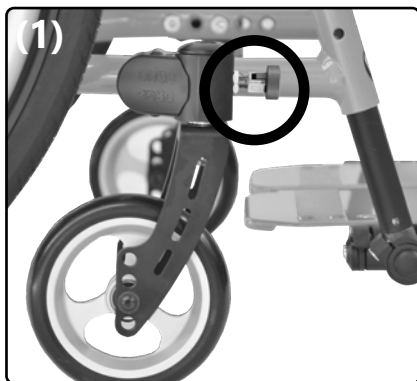

Lock:

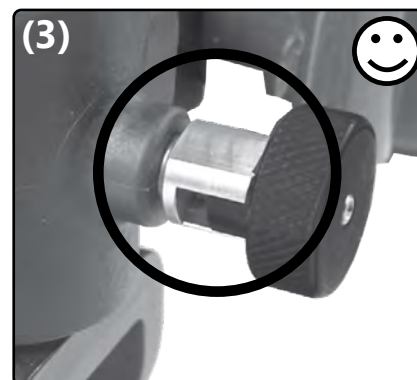
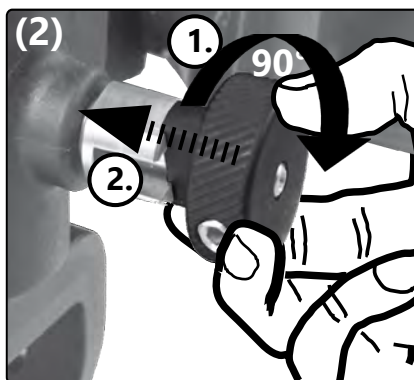
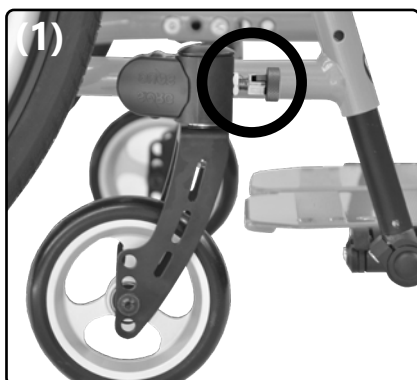

3.3 Handling seat and back

3.3.1 General information regarding back

Check the secure fit of the back after each change.

In the case of angle-adjustable backs or (seating unit) tilt mechanisms, it is essential to activate the anti-tipper from a setting of $> 90^\circ$. The head must be supported (e.g. by a headrest) during back angle-adjustment or tilting.

Only activate the (seating unit) tilt mechanism or angle adjustment with the brakes applied.

3.3.2 Fixed seat plate (SeatFix)

Insert (remove: proceed accordingly in reverse order):

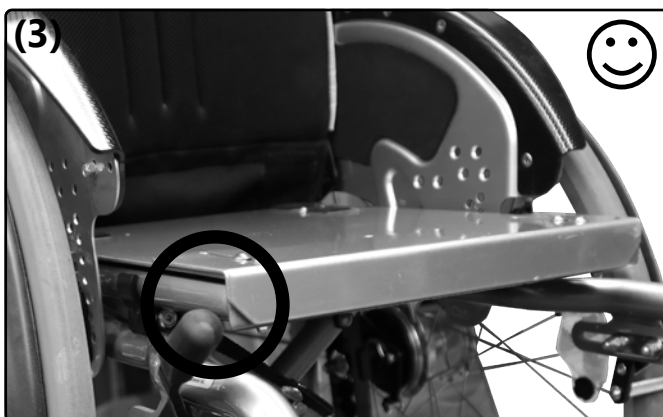
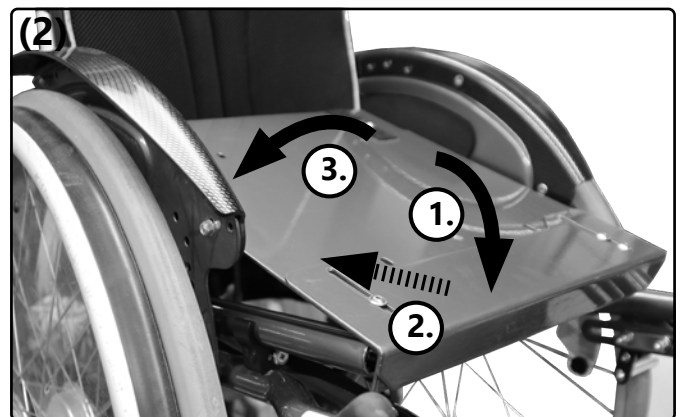

3.3 Handling seat and back

3.3.3 Fixed seat plate with locking mechanism (SeatFix)

Lock:

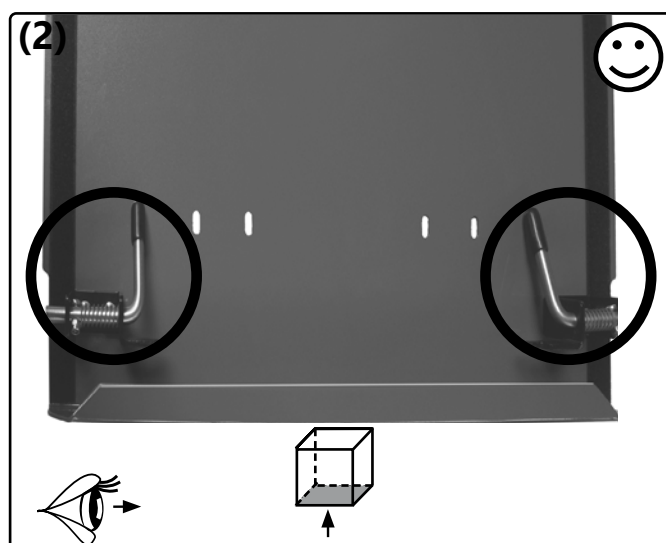
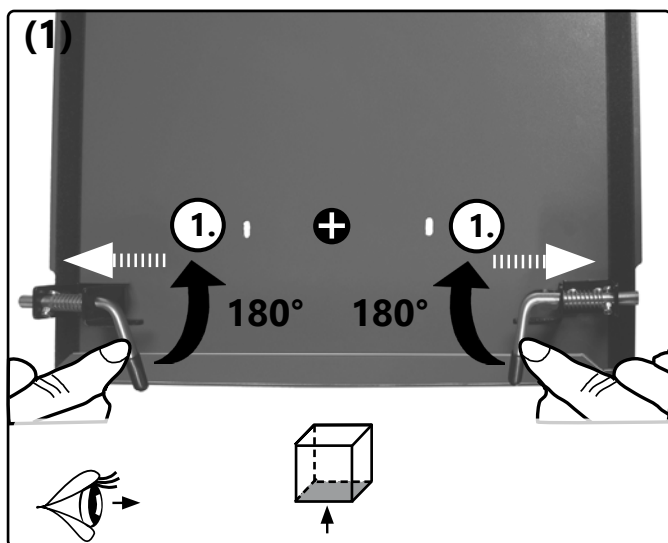

Unlock:

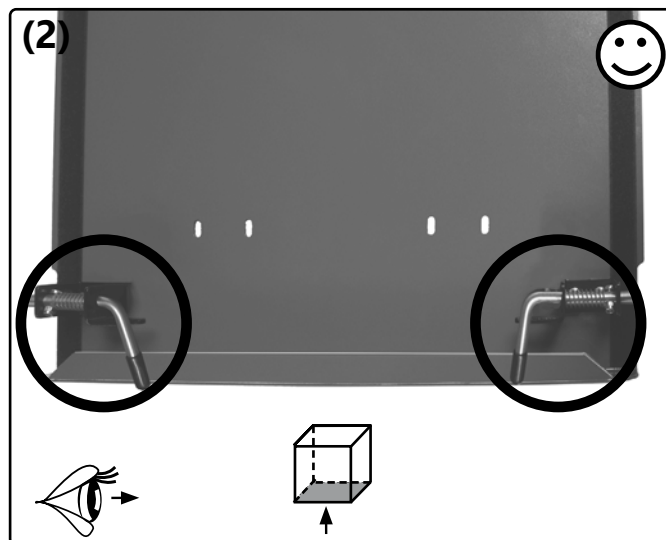
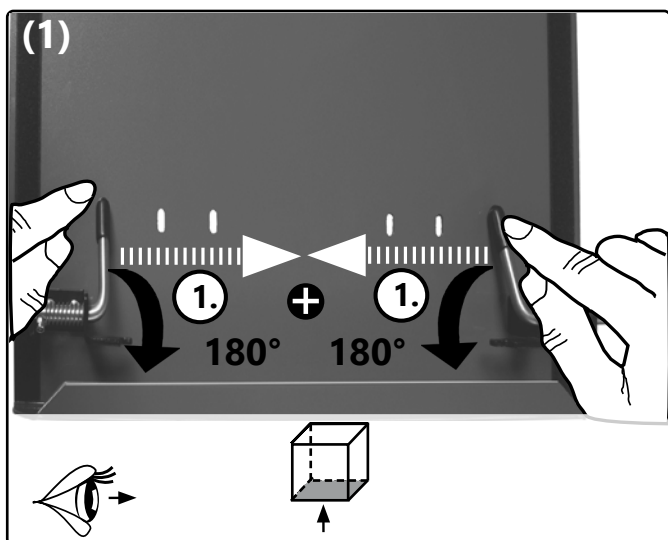

3.3 Handling seat and back

3.3.4 Firm curved back plate

Lock:

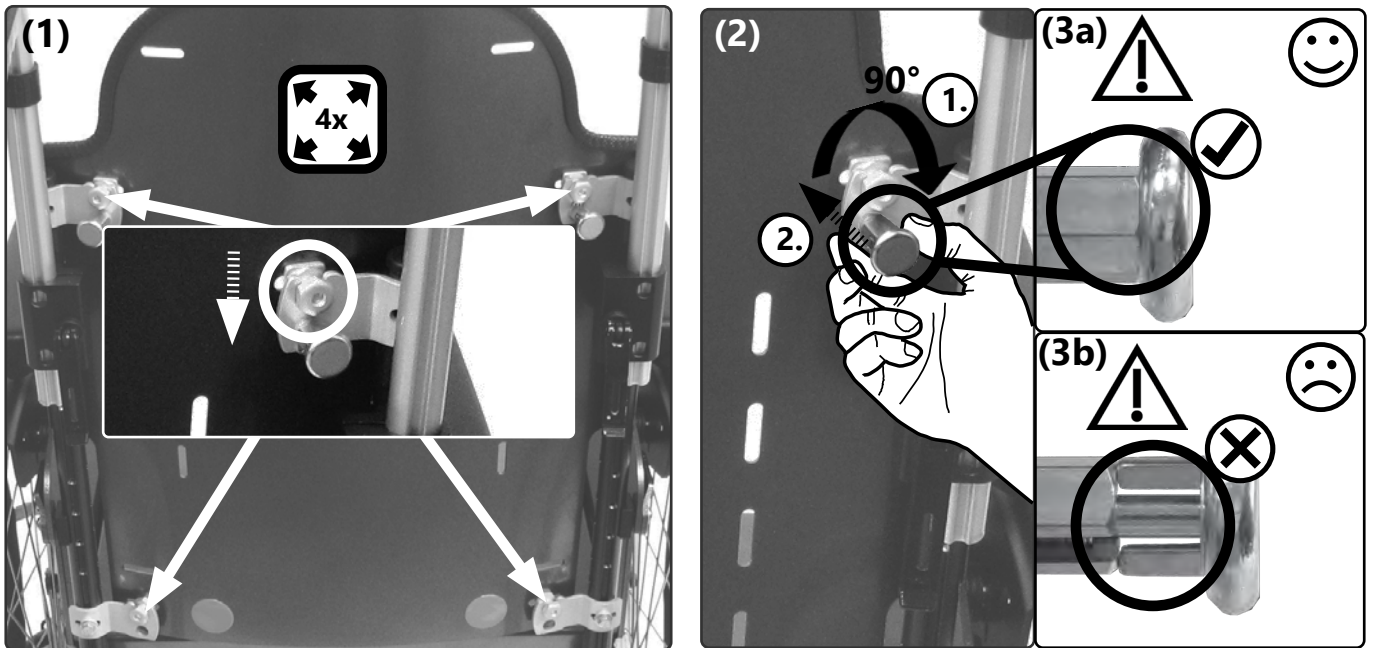

Unlock:

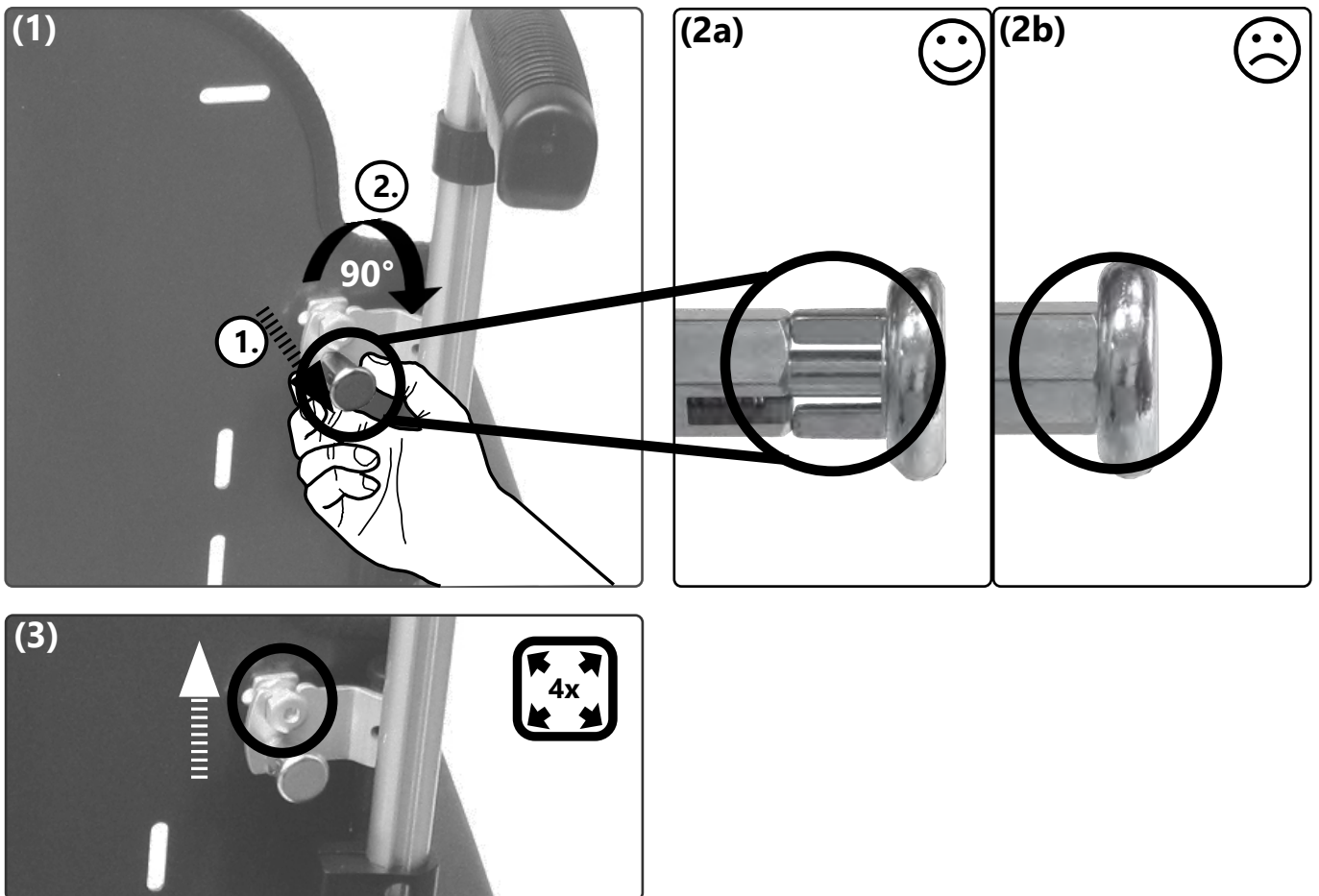

3.3 Handling seat and back

3.3.5 Back with raster

Shift:

The anti-tipper must always be activated before a new back angle position is used.

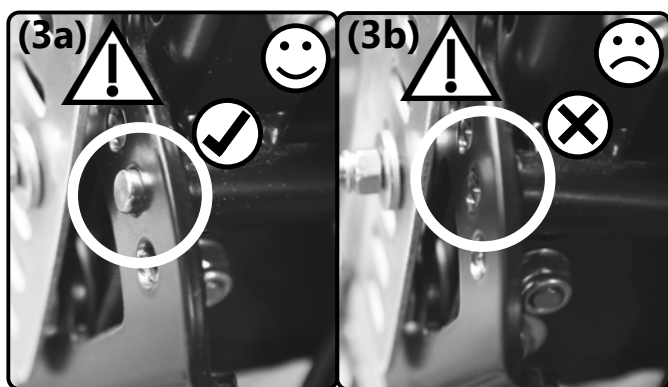
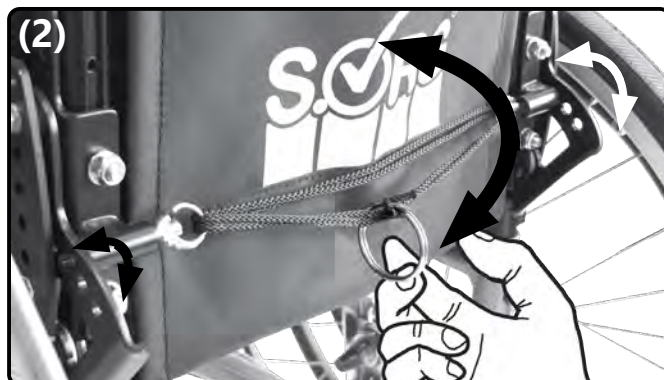
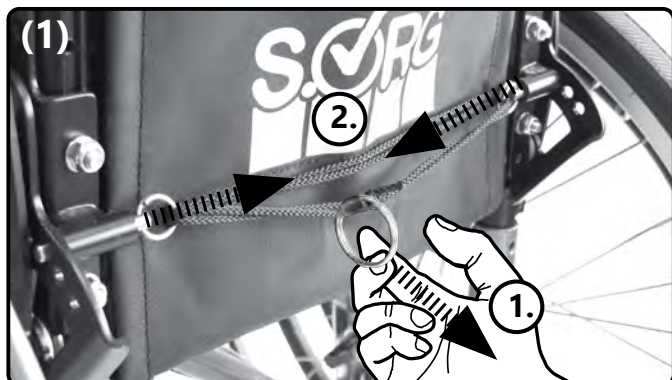

Fold down (straighten: proceed accordingly in reverse order):

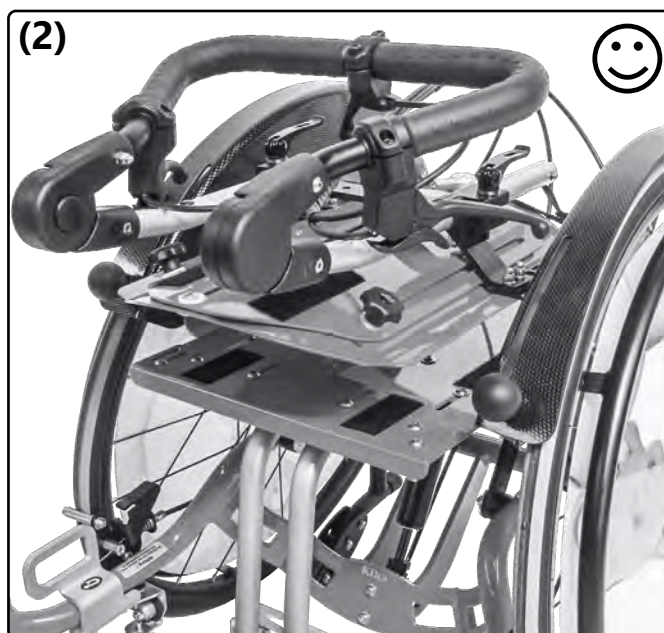
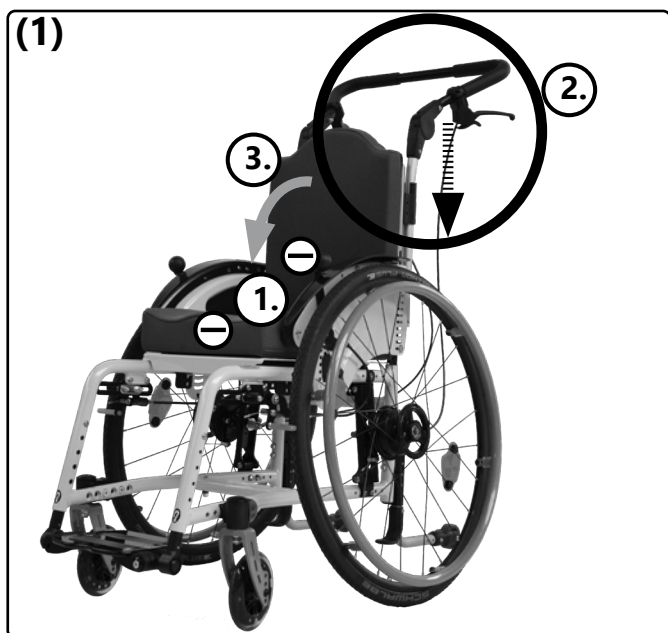

3.3 Handling seat and back

3.3.6 Back with gas pressure spring

Shift:

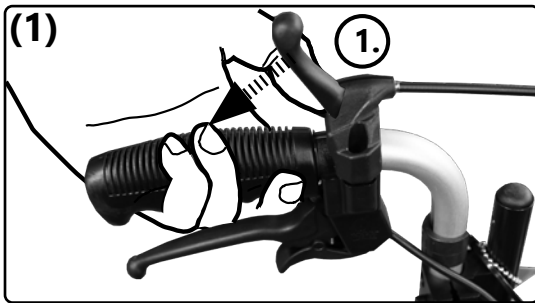

3.3.7 Back extension

Pull out (lower: proceed accordingly in reverse order):

The lowerable back extension is **not** suitable as a headrest in a motor vehicle!

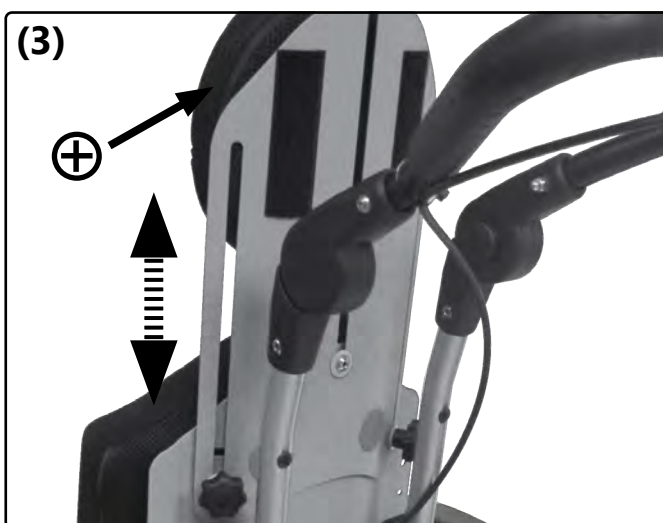
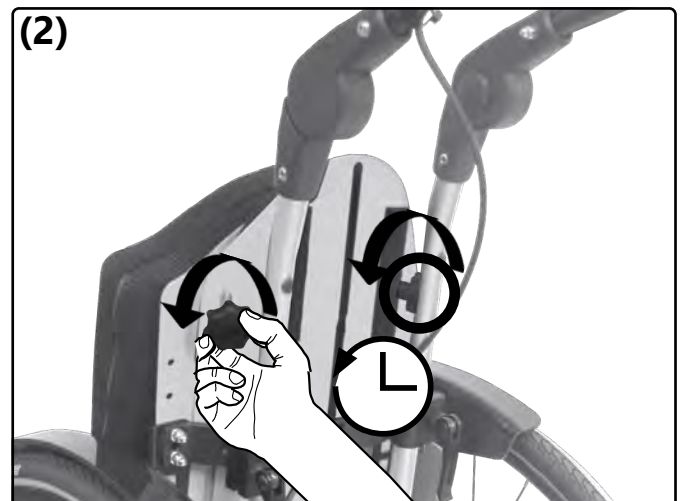

3.4 Handling side guard

3.4.1 General information regarding side guard

Open/ swivel away and remove:

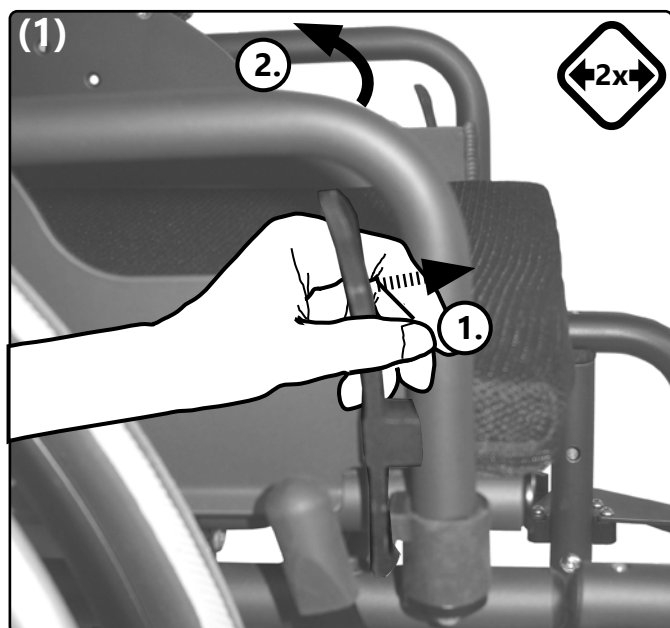

Close: Proceed accordingly in reverse order:

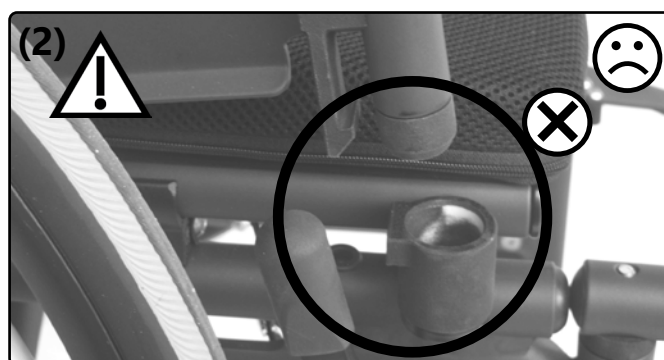
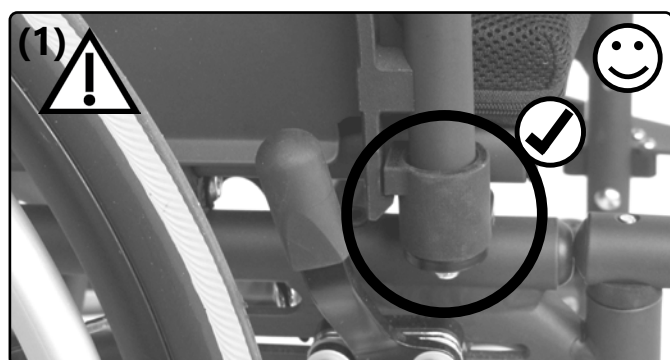

3.4.2 Arm rests

Set height:

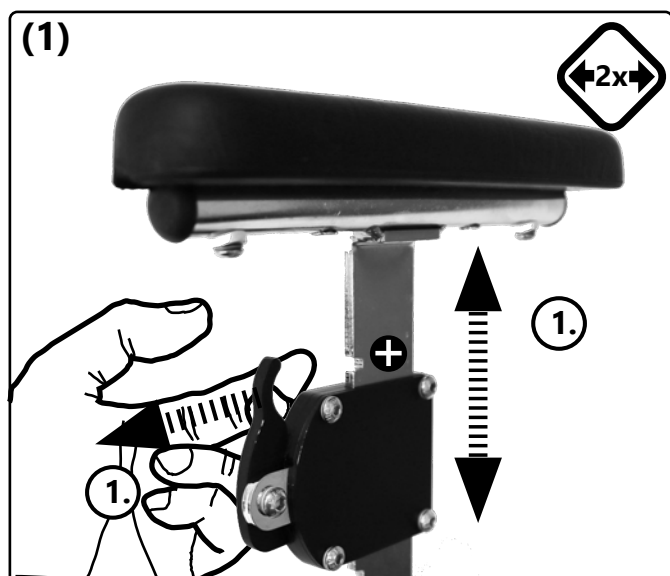

3.5 Handling folding up and unfolding

3.5.1 General information regarding folding up and unfolding

When folding the wheelchair, pay attention to the crushing hazard posed by the crossbrace.

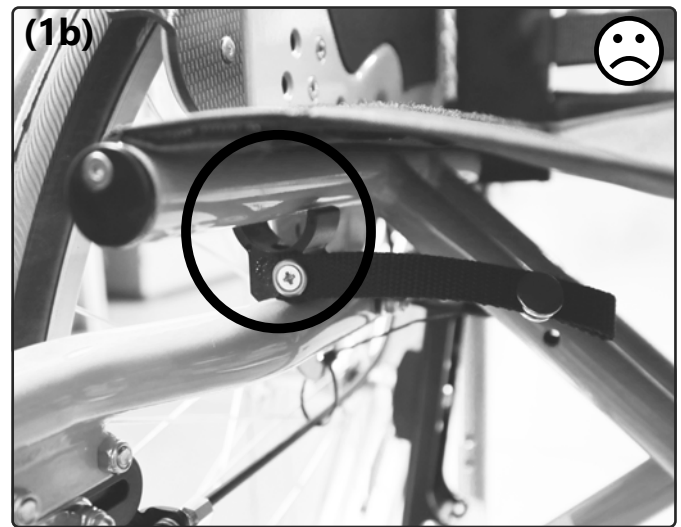
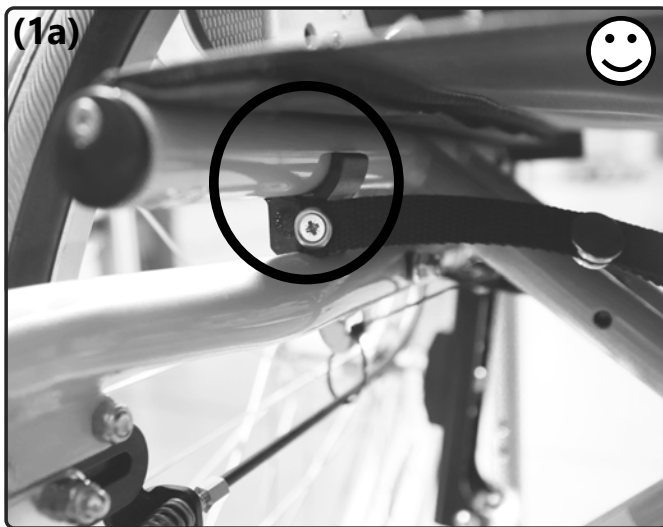

Stabiliser bar:

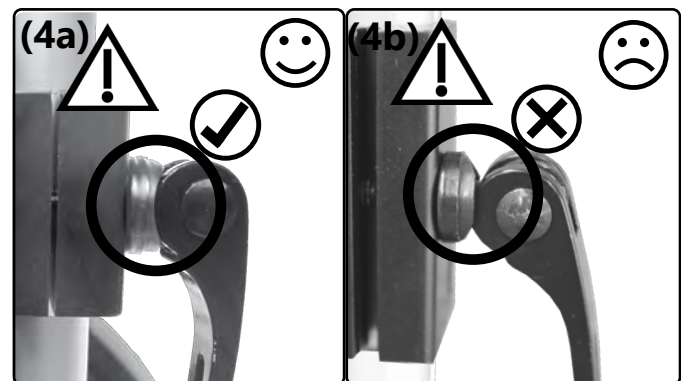
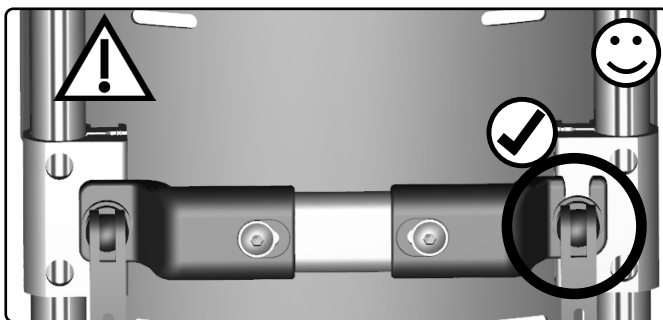

The notch **(A)** of the stabiliser bar must be seated up to the stop in the guide of the eccentric clamp **(B)** and this must be firmly closed.

3.5 Handling folding up and unfolding

3.5.2 of seat and back cover

Fold up (unfold: proceed accordingly in reverse order):

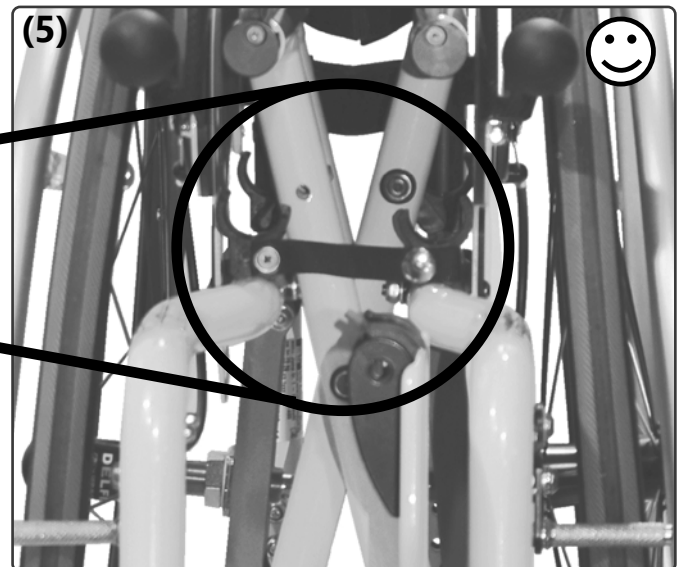
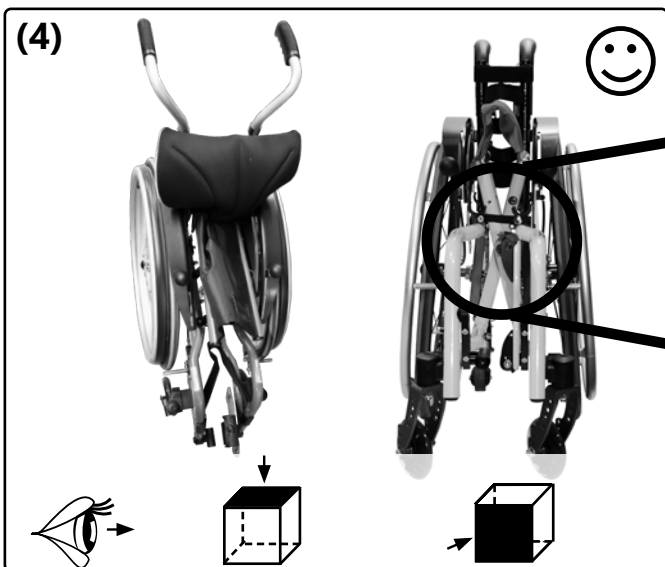
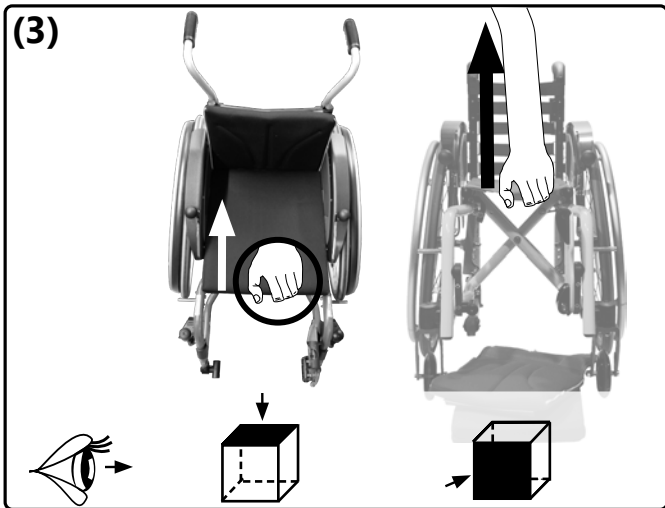
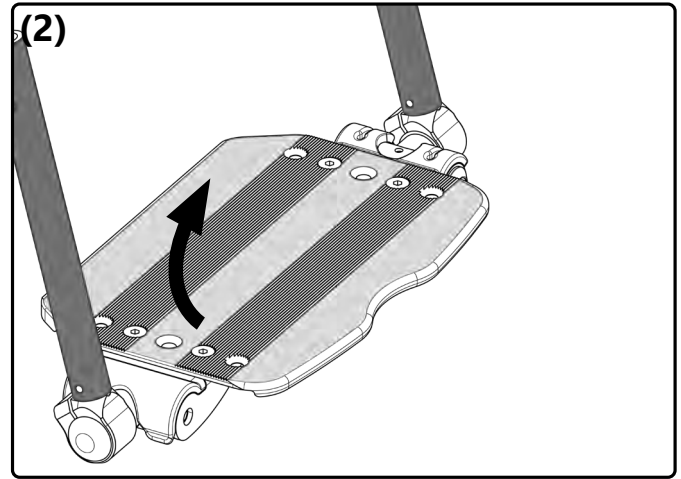
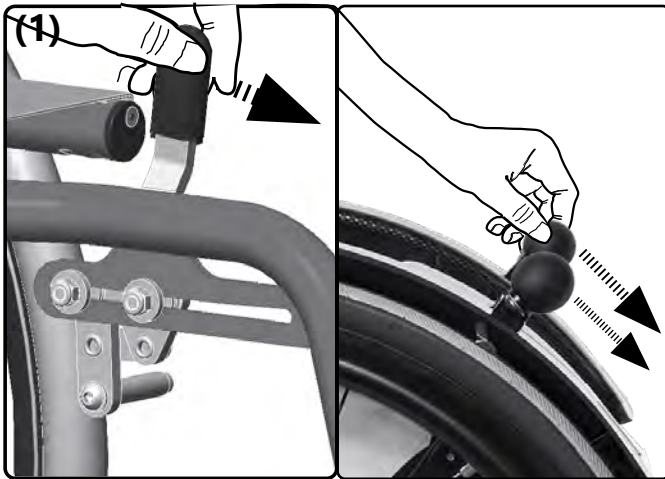

3.5 Handling folding up and unfolding

3.5.3 of SeatFix and/or firm curved back plate

Fold up (unfold: proceed accordingly in reverse order):

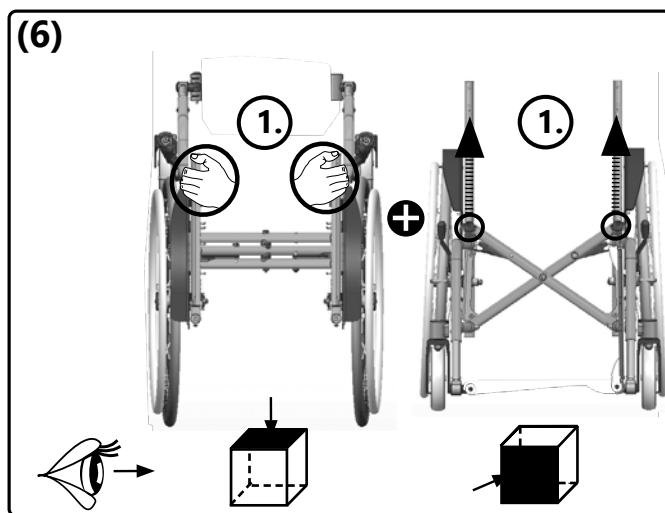
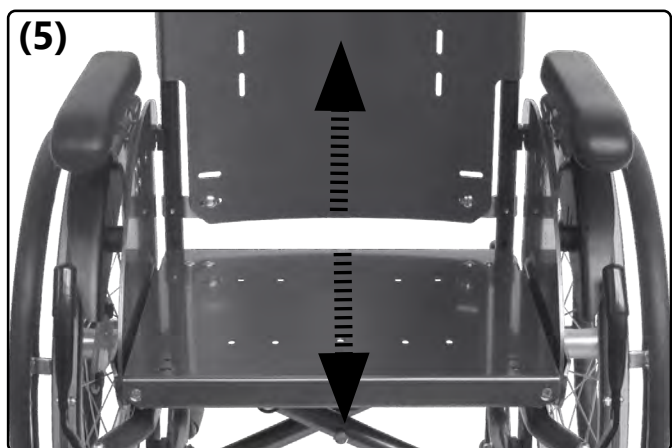
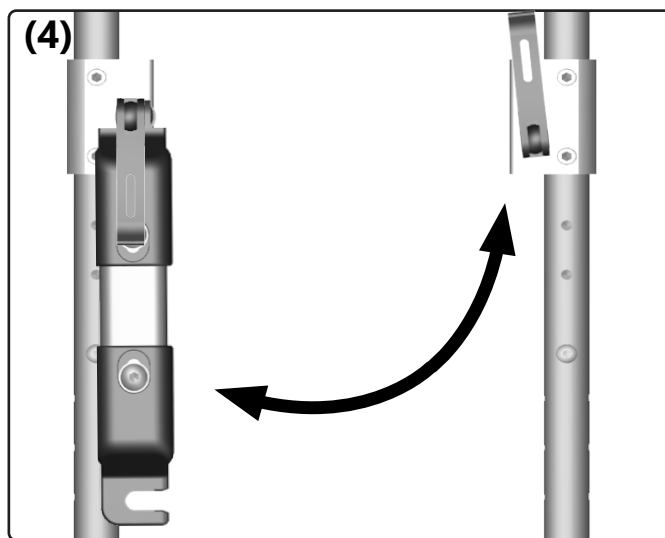
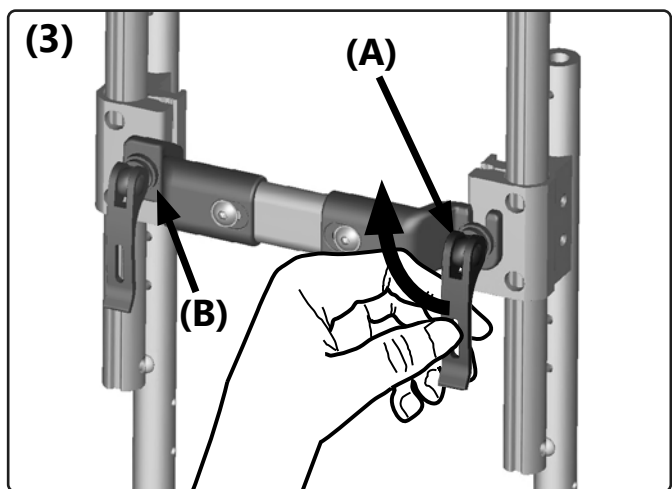
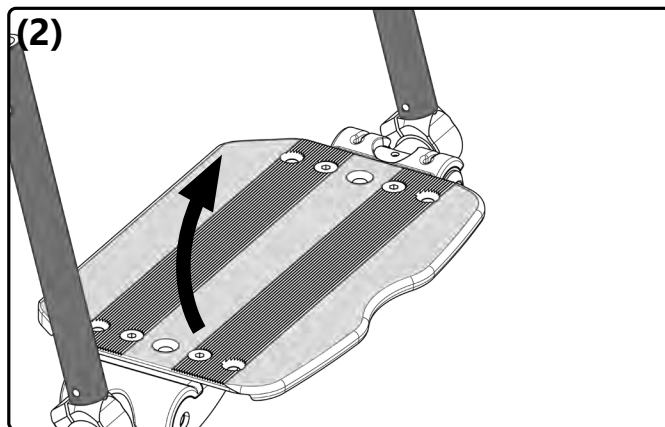
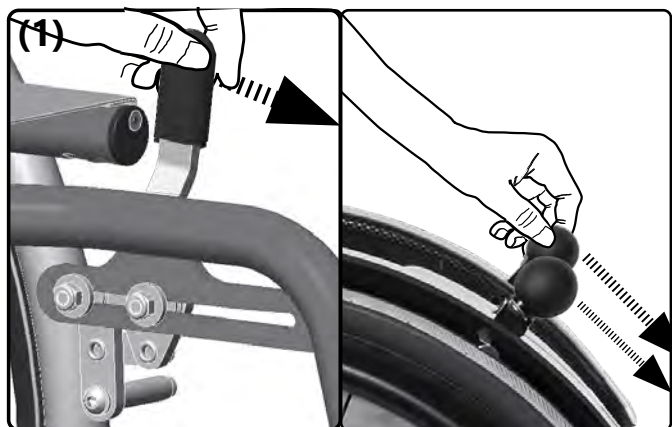

3.6 Handling pushing aid

3.6.1 General information regarding pushing aids

All height-adjustable pushing aids are designed exclusively to push the occupant in their wheelchair – **not to carry them**.

Children are not able to competently judge the swivel range of protruding pushing aids and may injure others while playing. We recommend folding back or dismantling the pushing aids in such cases.

Check that the eccentric clamps are tightly closed and in good working order before each use of the pushing aids. It must not be possible to move the pushing aids in the intake with the eccentric clamp(s) in the closed position.

Set the eccentric clamp:

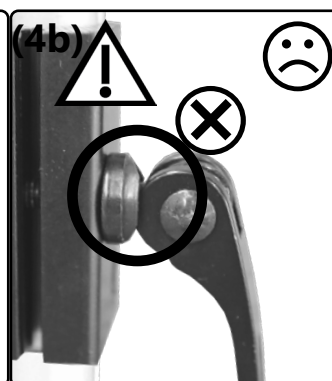
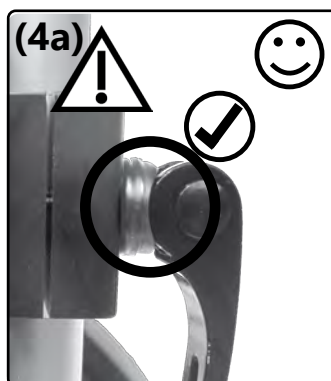
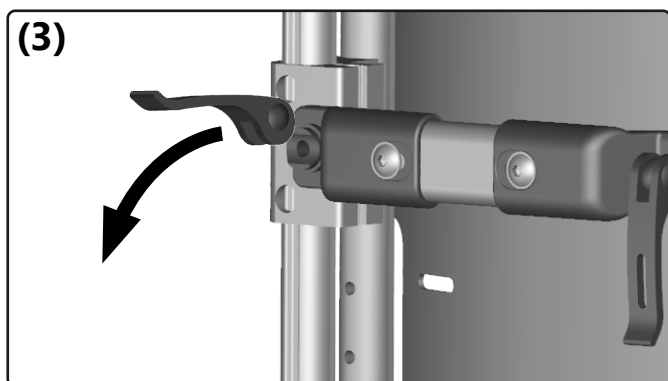
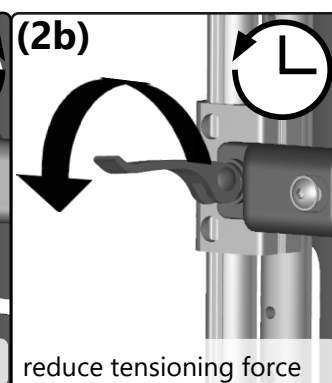
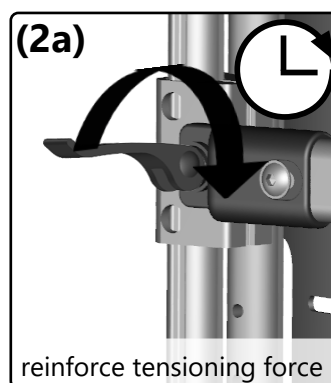
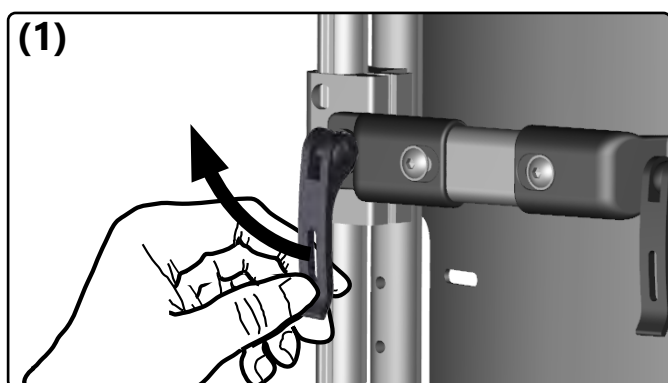

3.6 Handling pushing aid

3.6.2 Push handles

Set height:

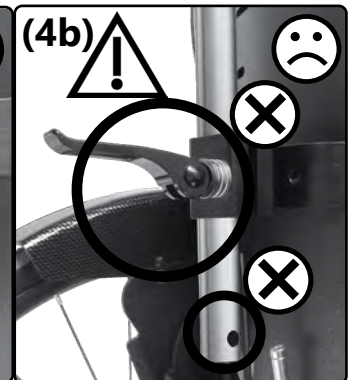
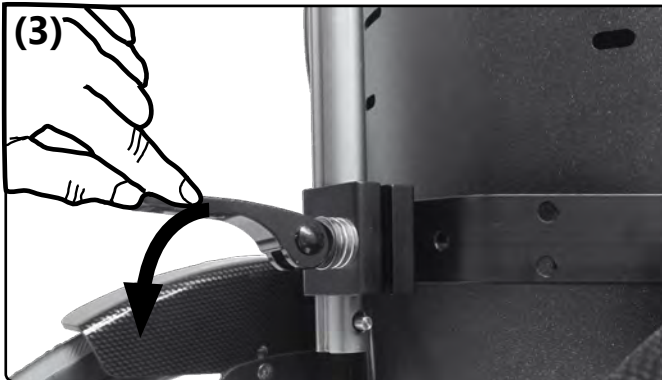
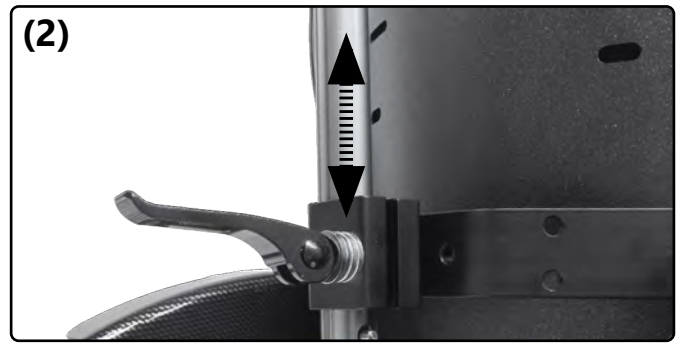
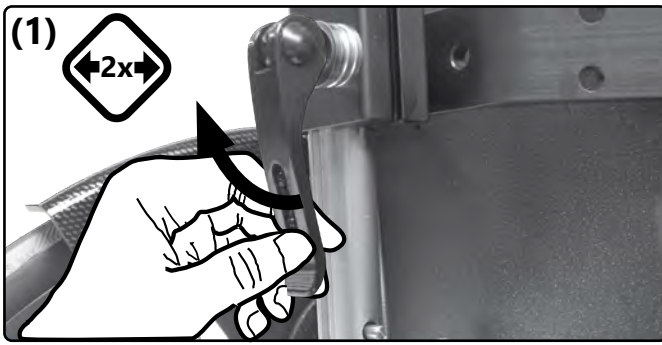

Insert (remove: proceed accordingly in reverse order):

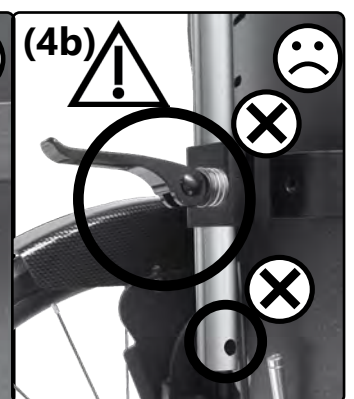
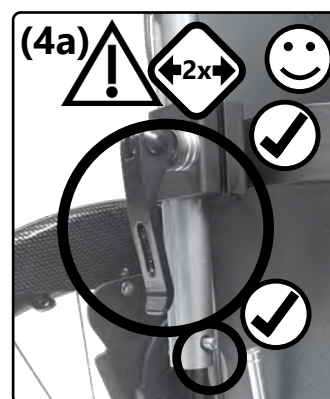
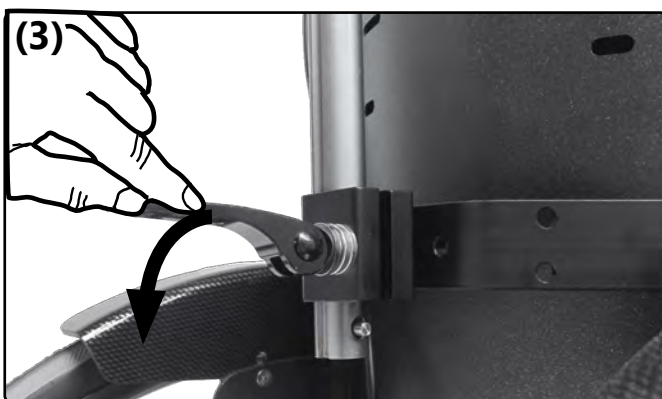
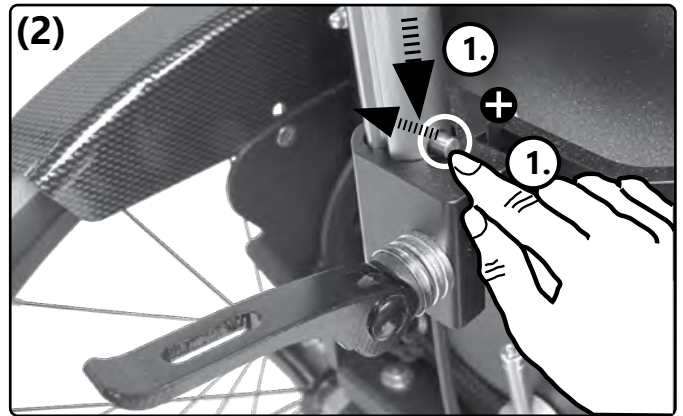
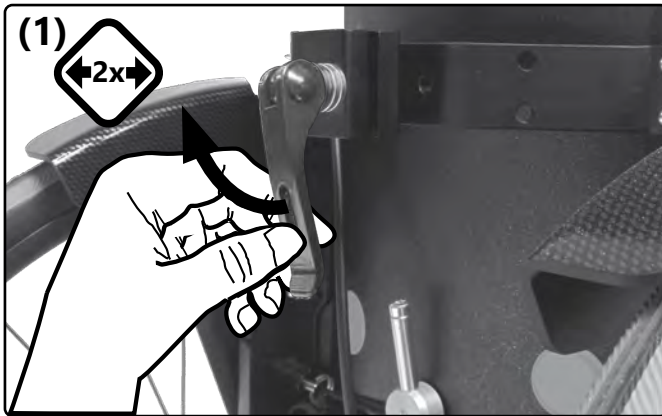

3.6 Handling pushing aid

3.6.3 Handle bar

Swivel up (swivel out: proceed accordingly in reverse order):

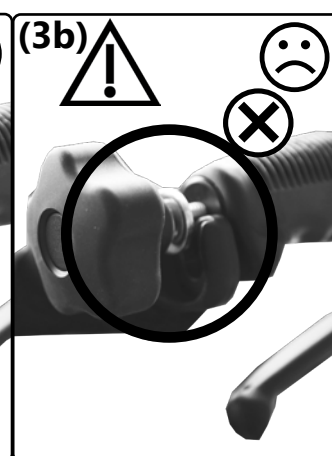
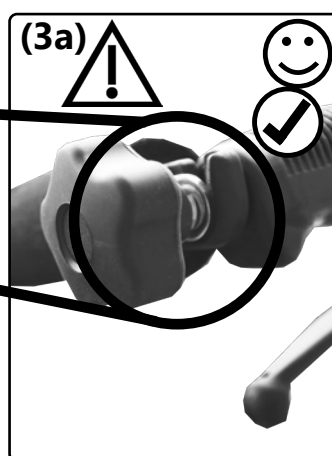
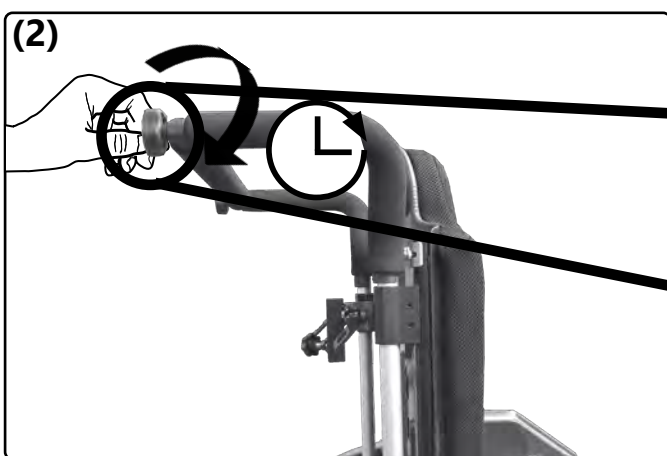
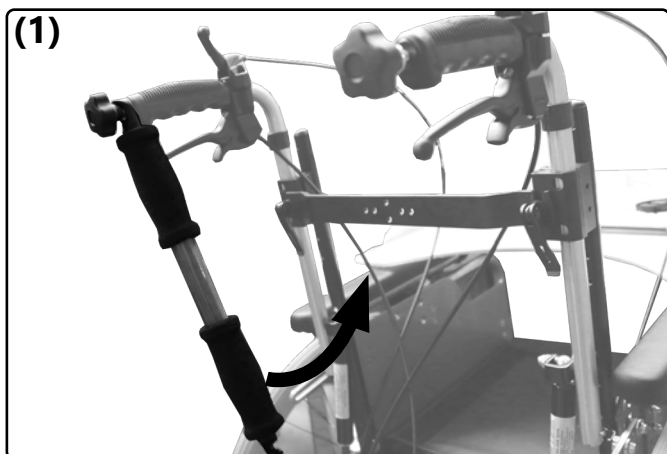

The handle bar is only intended for pushing, not for pulling or overcoming obstacles.

3.7 Handling leg support

3.7.1 General information regarding leg supports

Types of leg supports and their handling:

Model 1:

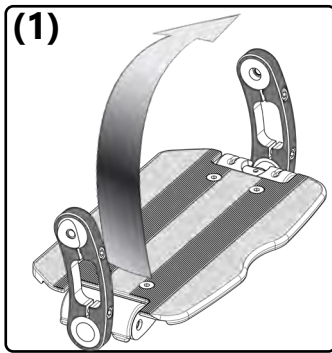

Model 2:

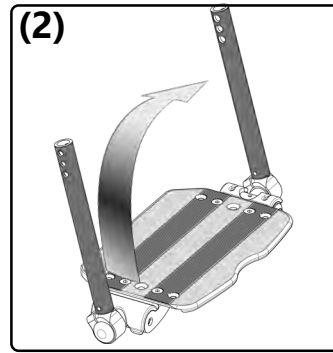

Model 3:

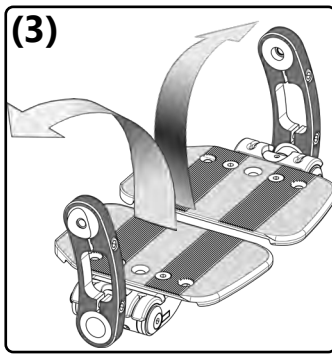

Model 4:

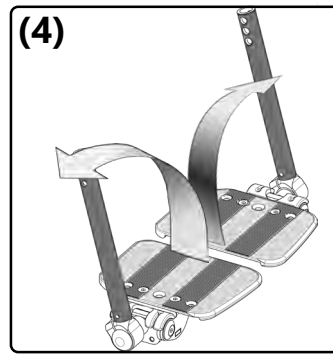

Model 5:

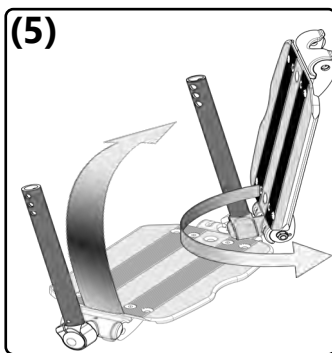

Model 6 **Jump beta BSA:**

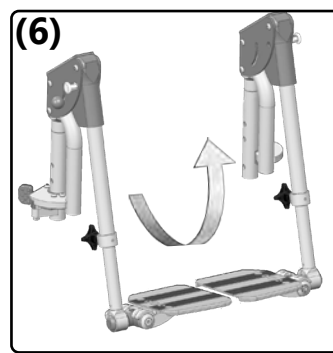

3.7 Handling leg support

3.7.2 Foldable footrest with locking mechanism

Outdoor attachment Lock (unlock: proceed accordingly in reverse order):

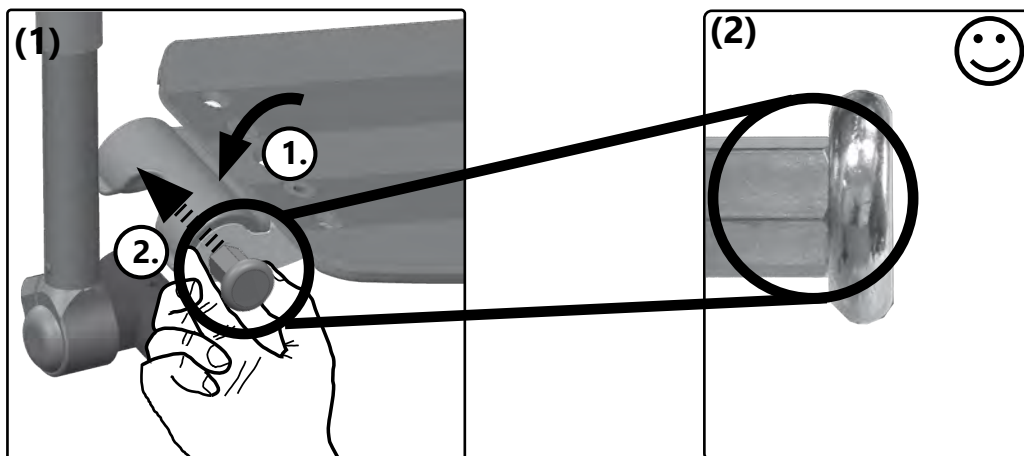

! As the occupant, make sure that you do not lean too far out of the wheelchair when handling the locking mechanism.

Lock (unlock: proceed accordingly in reverse order):

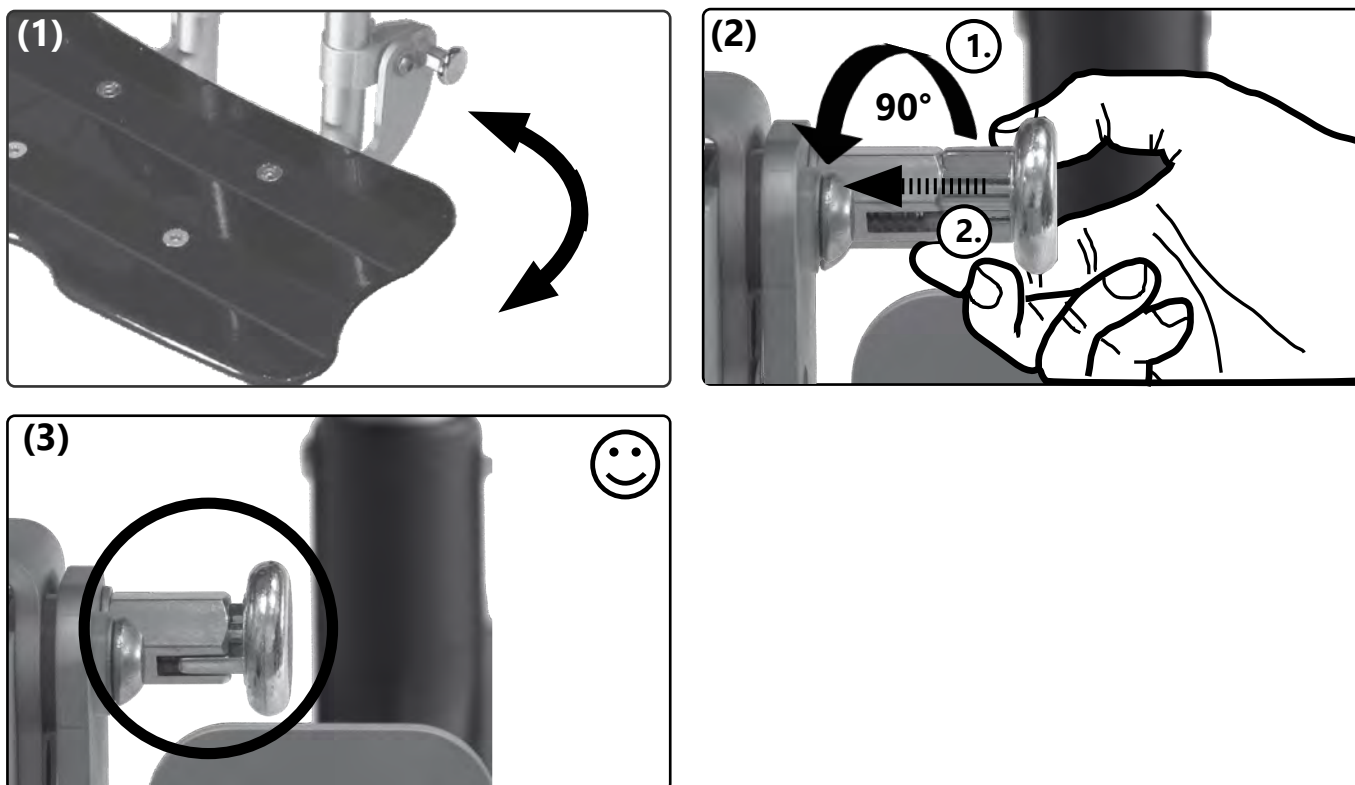

3.7 Handling leg support

3.7.3 Detachable and swivelling leg support (Jump beta BSA)

Attach (detach: proceed accordingly in reverse order):

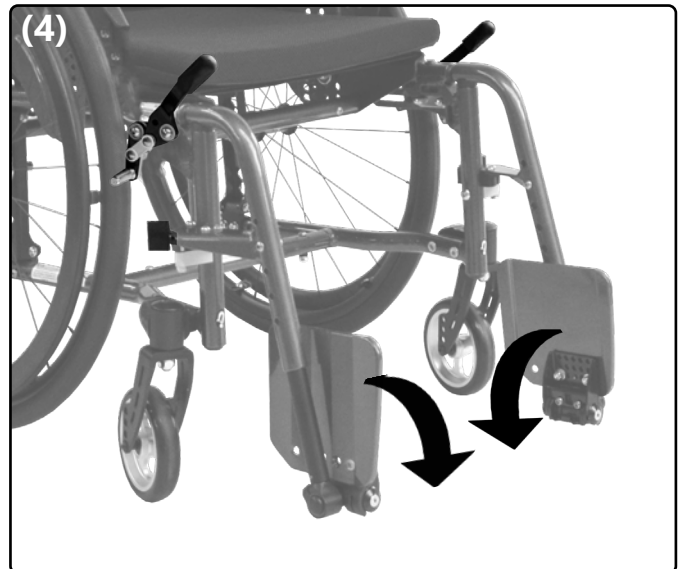
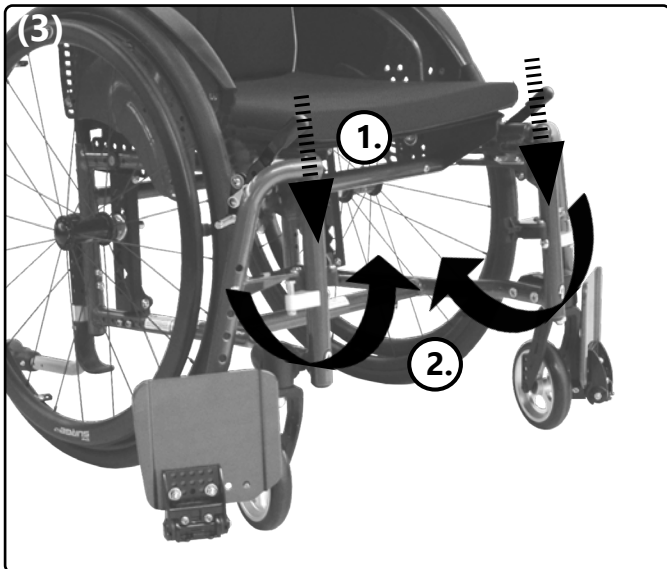
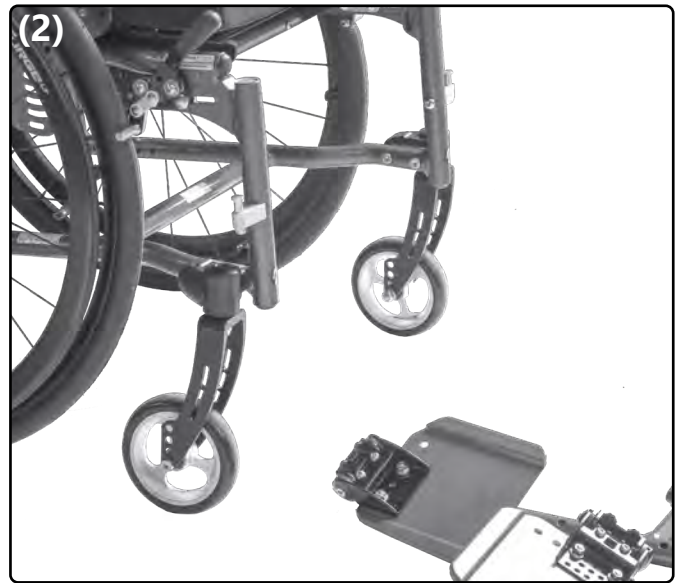
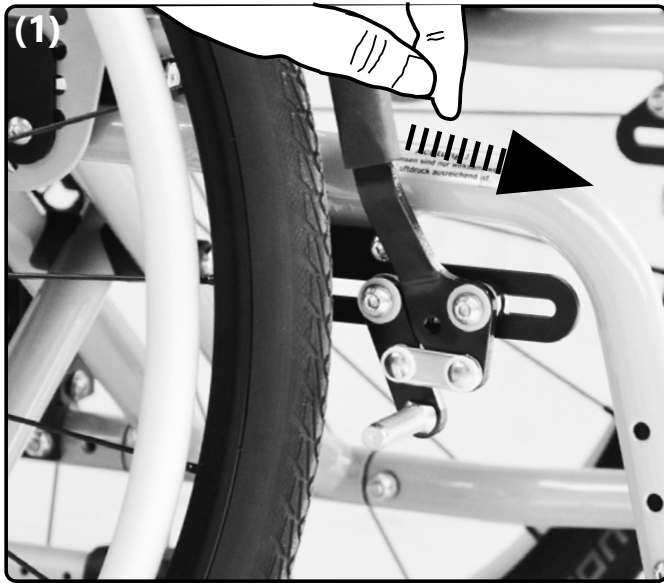

3.7 Handling leg support

Swivel out (swivel back: proceed accordingly in reverse order):

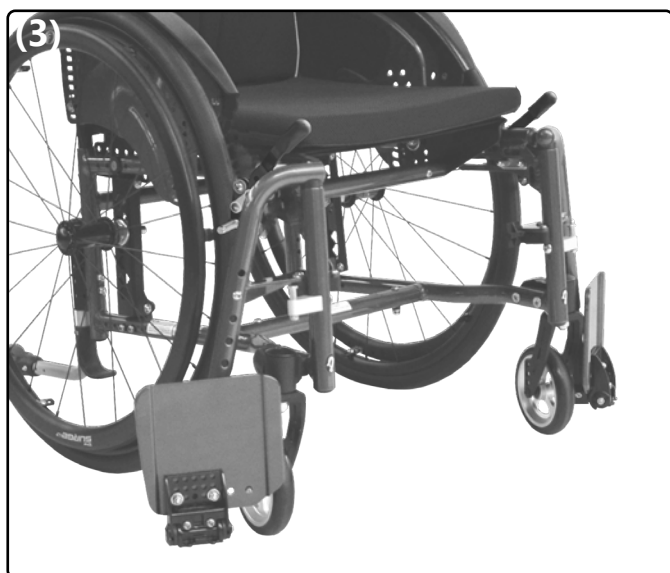
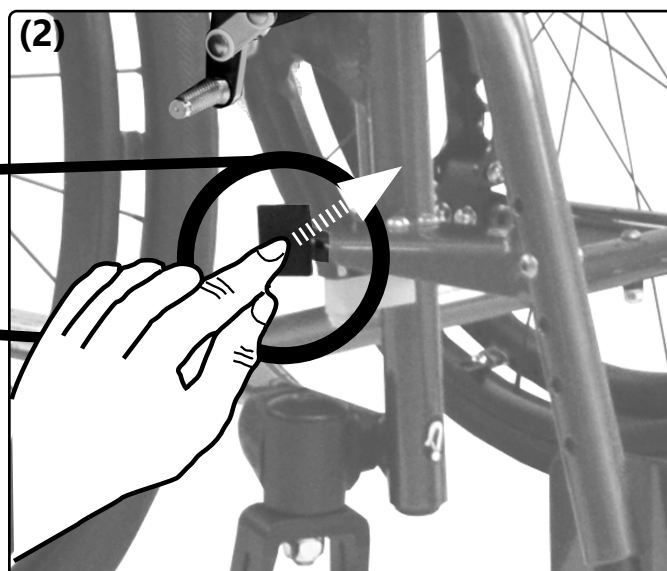
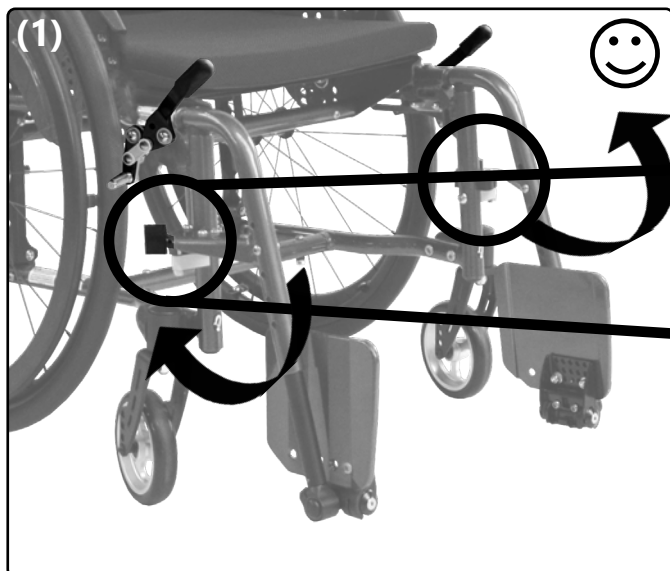

Set lower leg length:

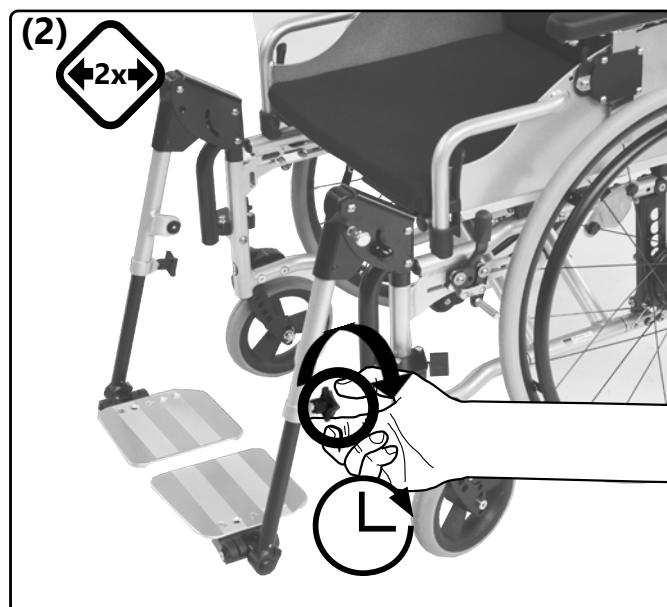
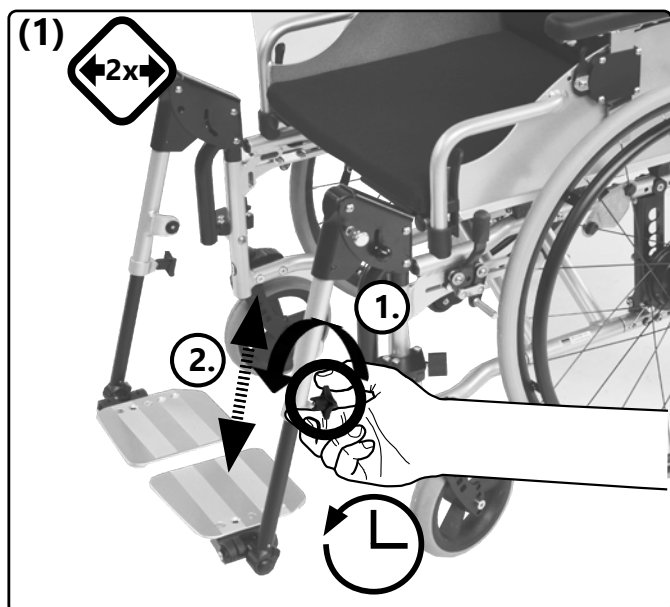

3.7 Handling leg support

Swivel up (swivel out: proceed accordingly in reverse order):

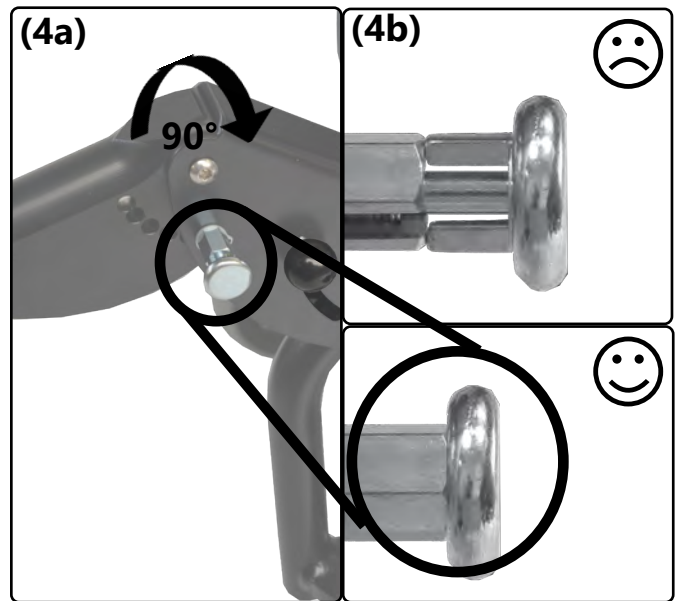
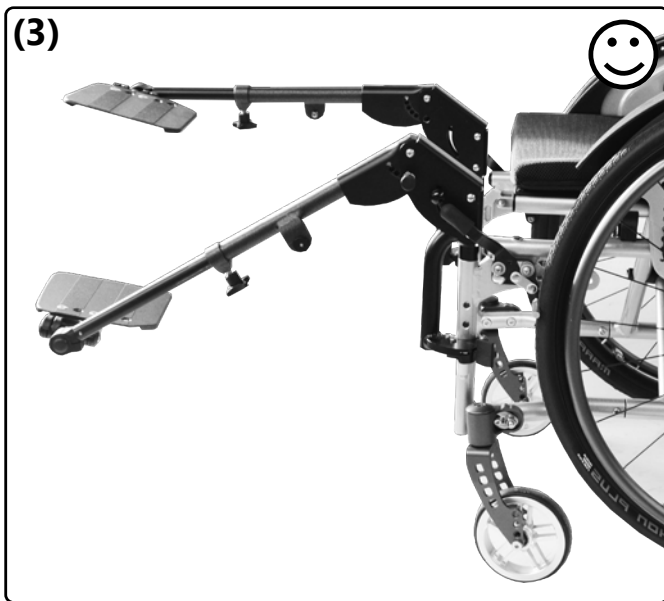
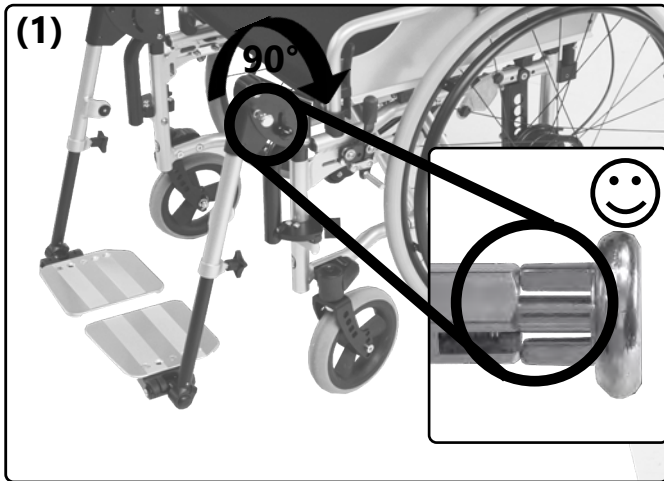

Swivel out: Proceed accordingly in reverse order:

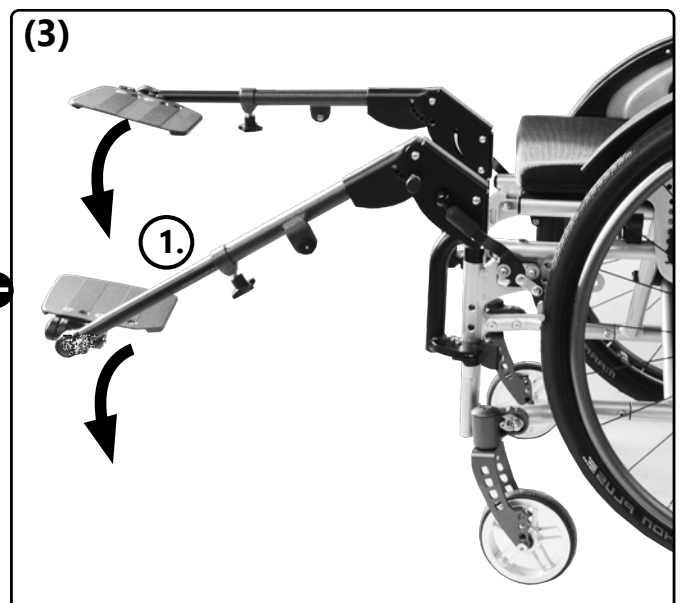
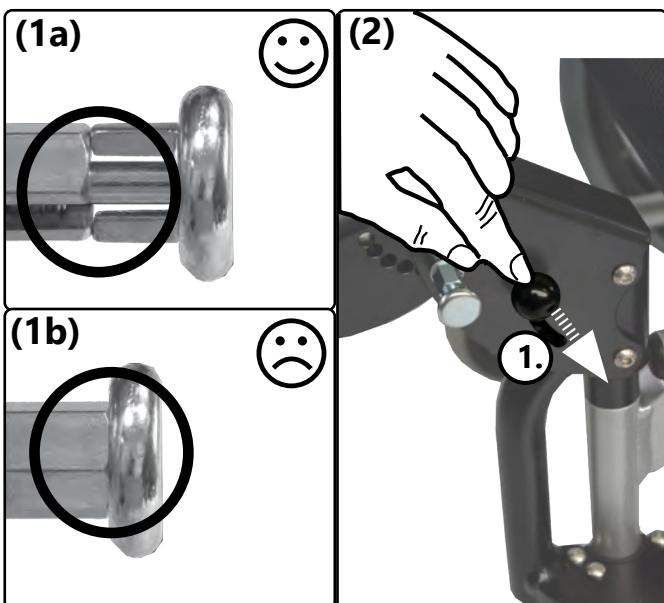

3.8 Handling brake

3.8.1 General information regarding brakes

Check that the brakes are in good working order before moving! Immediately contact your dealer if the braking effect deteriorates.

Possible impairments or malfunctions may be caused by:

- contaminated or incorrectly adjusted brakes,
- defective cable controls,
- too large a distance between brake pressure bolt and tyres,
- insufficient tyre inflation pressure (information on the tyre casing),
- wetness, snow, mud etc.,
- worn treads,
- worn or contaminated brake pressure bolts.

The wheelchair cannot be used until the brakes have had any malfunctions rectified.

Always check that the brakes are locked securely and in working order on downhill gradients.

3.8.2 Wheel lock

The knee lever and cable control brakes are wheel locks and are **not** suitable for slowing down when moving.

Locking the wheel with the knee lever brake:

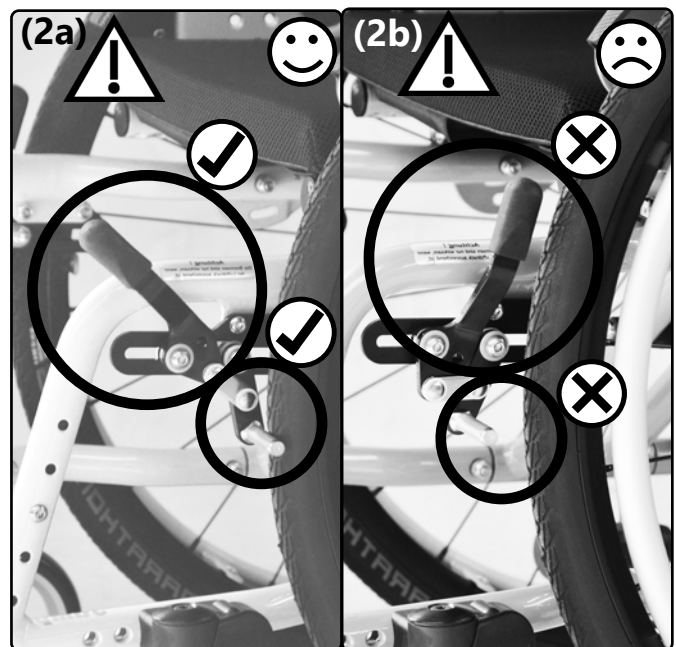
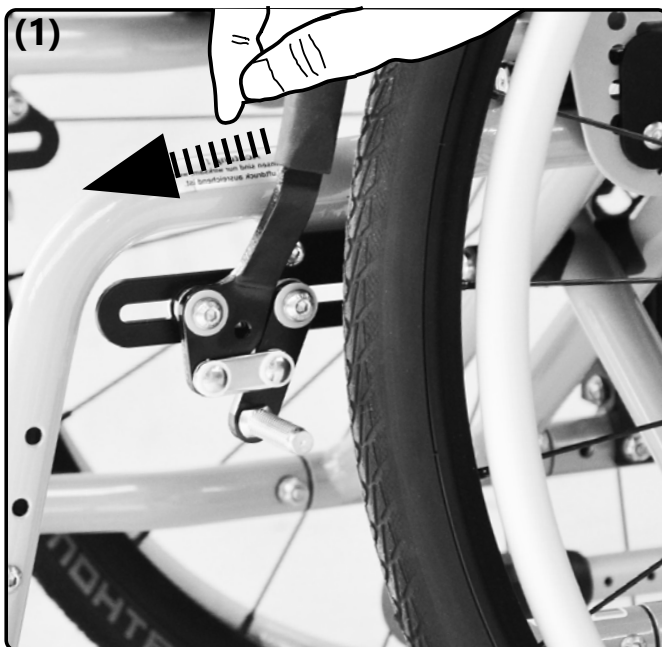

3.8 Handling brake

Locking the wheel with the cable control brake:

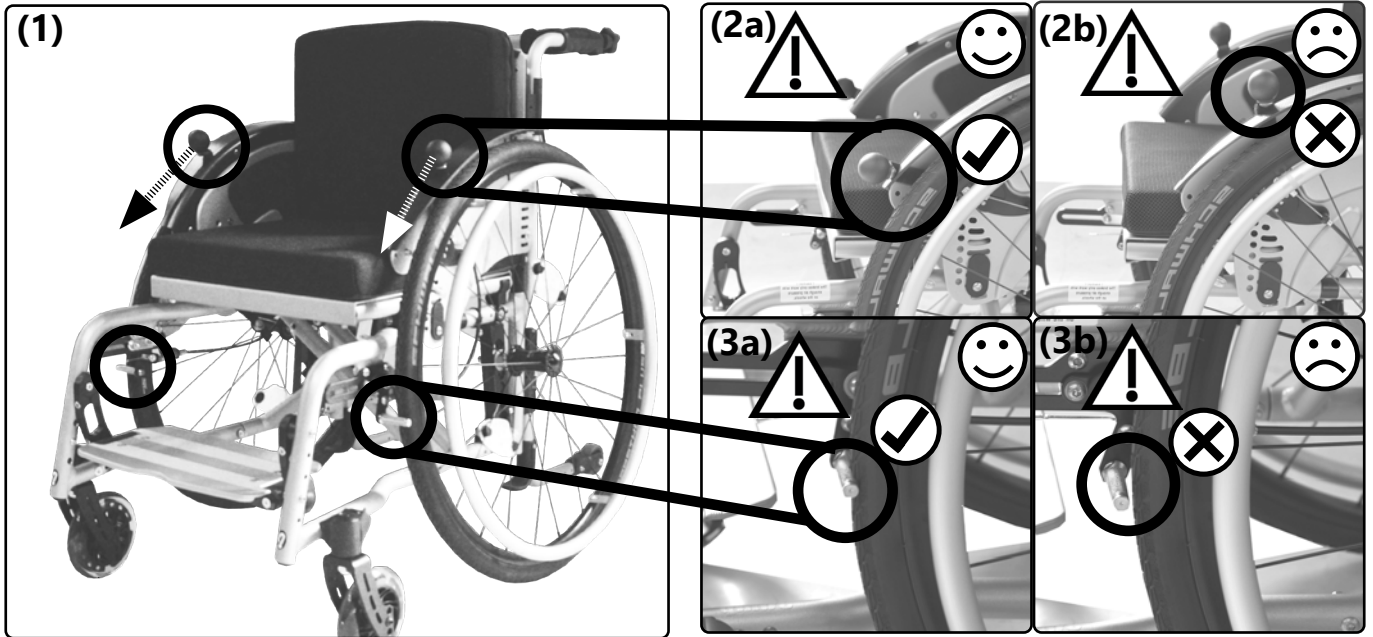

Locking in open or closed position:

First set the brake to the desired position (braked/unbraked).

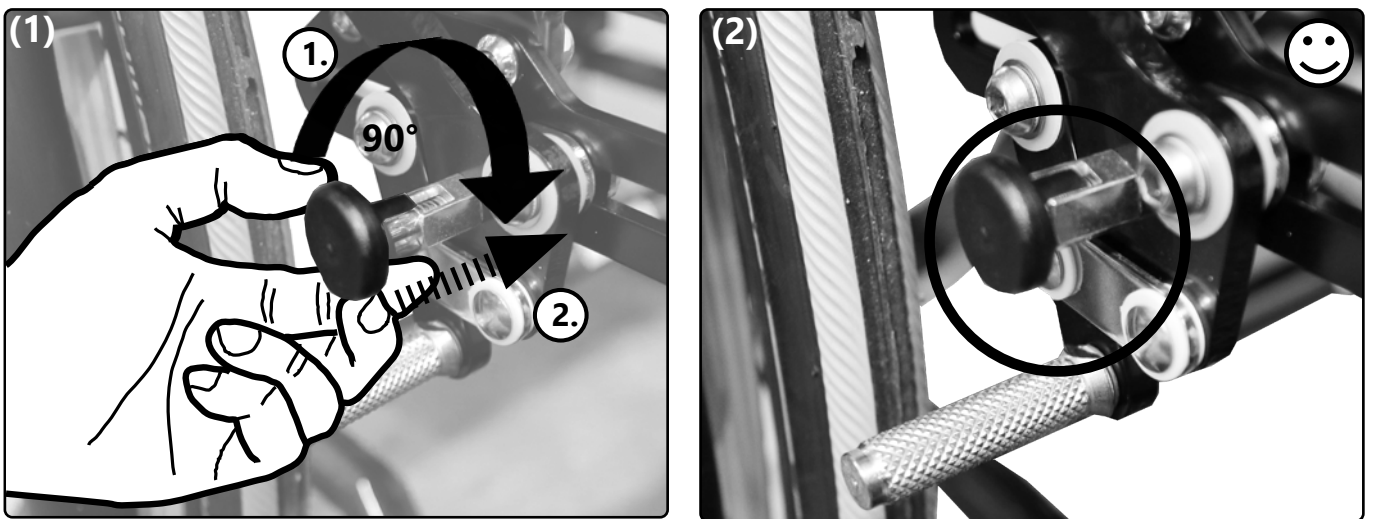

Unlock:

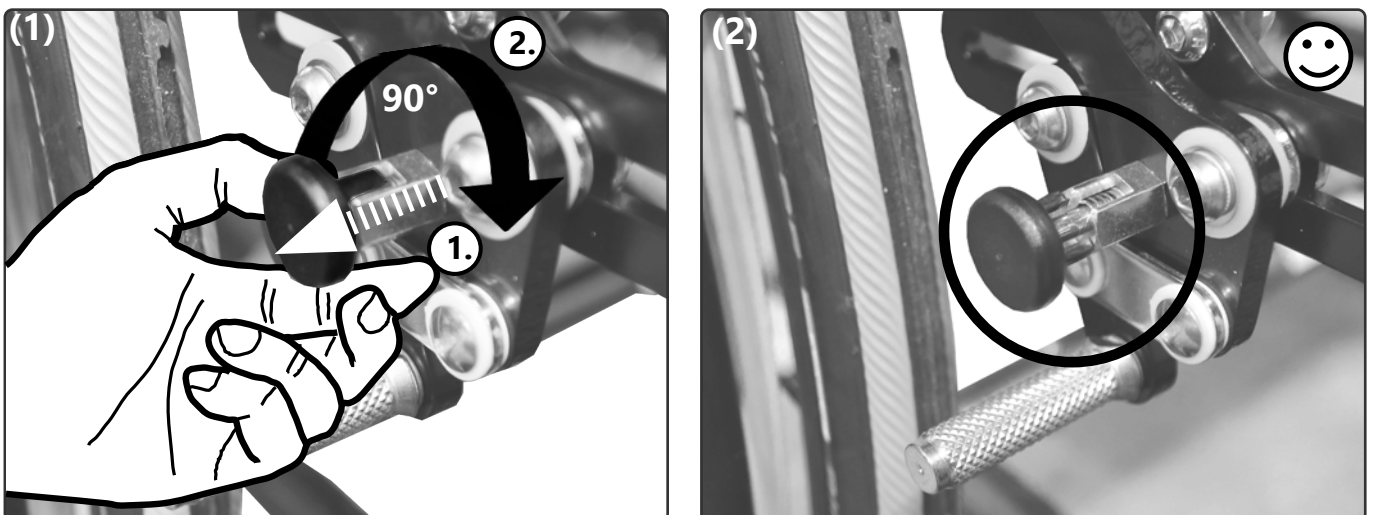

3.8 Handling brake

3.8.3 Drum brake

Slow down:



⚠ Unequal use of both brake levers results in cornering.

⚠ Clean the braking elements of the drum brake wheels at short intervals using a soft brush.

Lock:

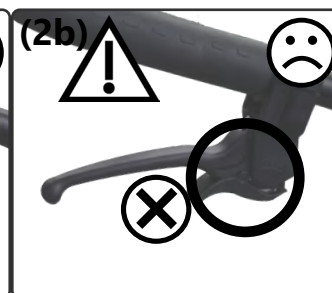
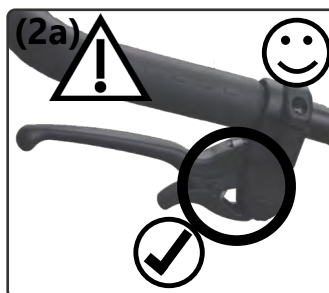
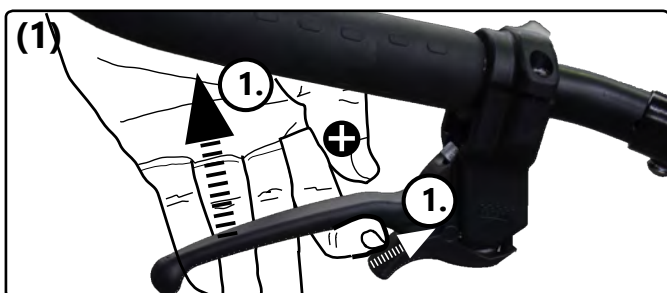

Release:



3.8.4 Reverse-roll locking

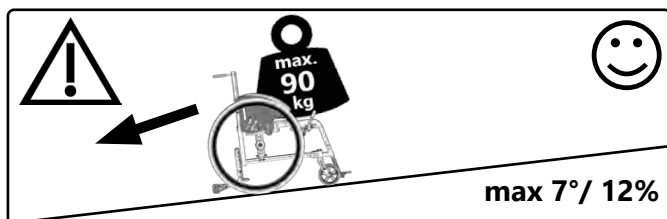

⚠ Not suitable in combination with auxiliary drives.

Activate (deactivate: proceed accordingly in reverse order):

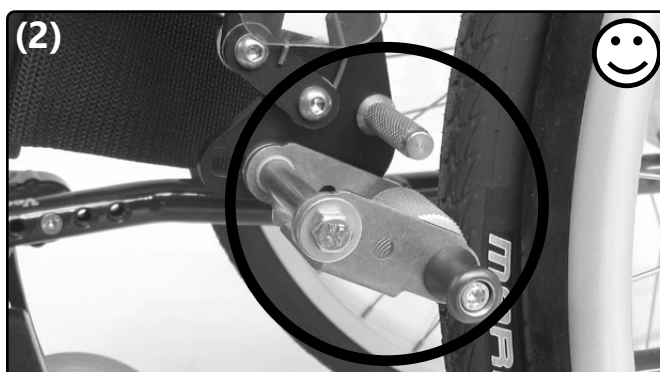
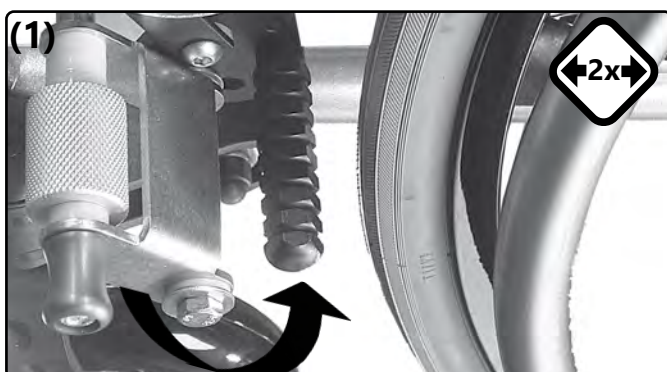

3.9 Handling anti-tipper

3.9.1 General information regarding anti-tipper

To improve tilting stability, a wheelbase extension, or at least an anti-tipper, must be used by people who have had leg amputations.

A wheelbase extension is **not** a replacement for an anti-tipper.

Activate:

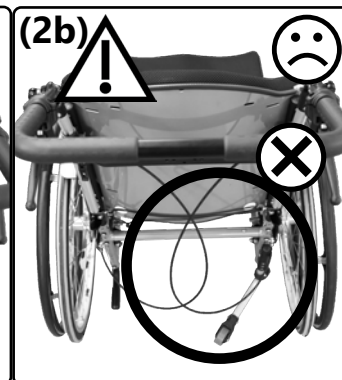
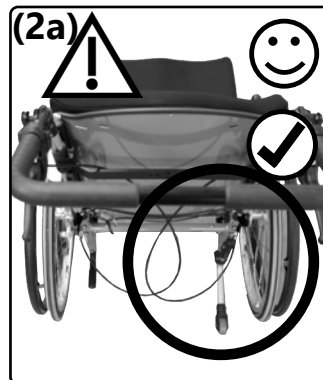
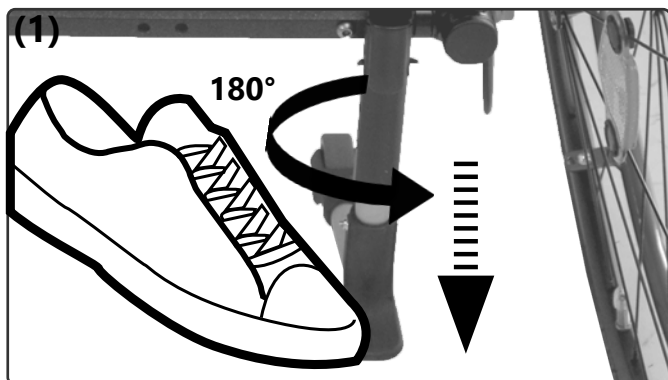

The anti-tipper must always be locked in its end position.

Deactivate:

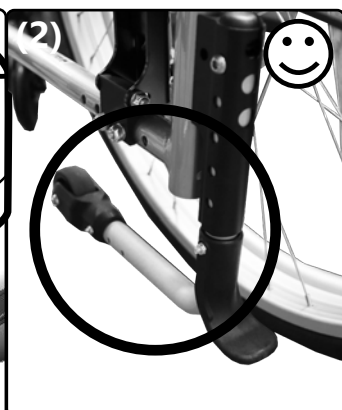
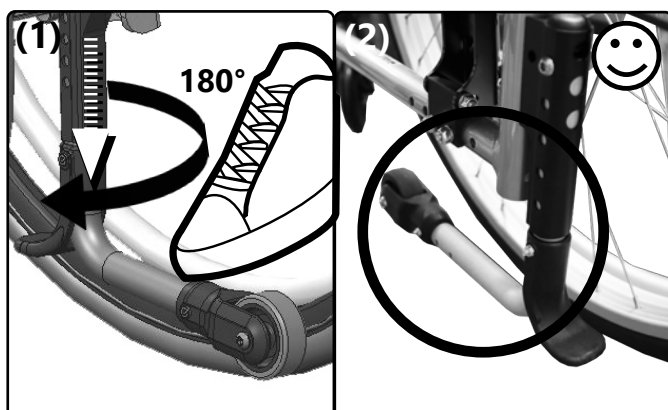

Only rotate the anti-tipper 180° from deactivated position to active position. Avoid full revolutions in one direction, since otherwise the tension spring inside the anti-tipper will be damaged, which may result in the anti-tipper losing its functionality.

3.10 Handling headrest

3.10.1 General information regarding headrest

Set distance:

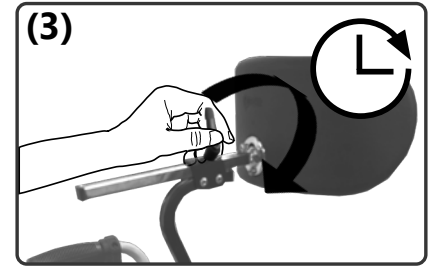
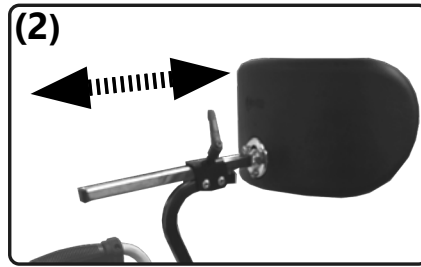
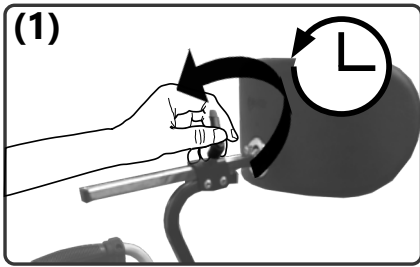

Set height:

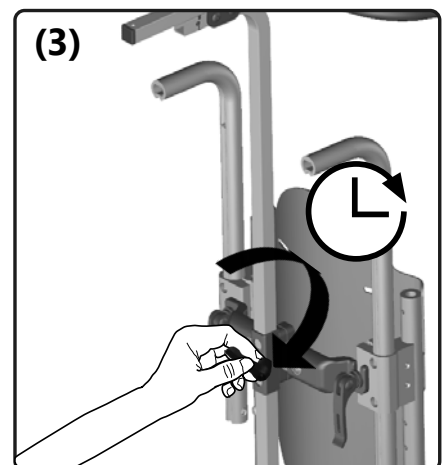
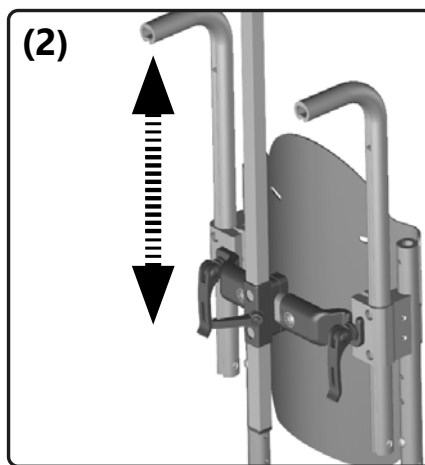
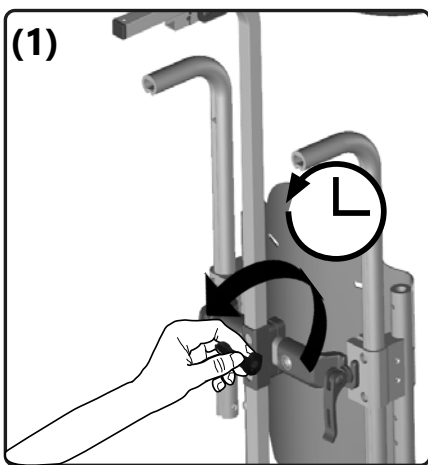

3.11 Handling abduction wedge

3.11.1 General information regarding abduction wedge

Set distance:

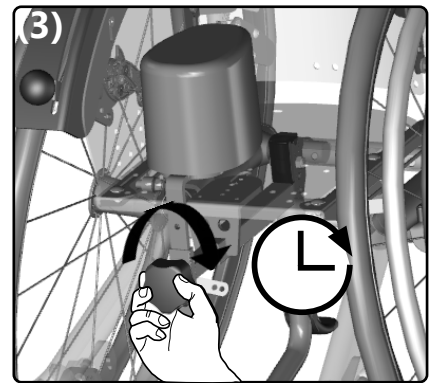
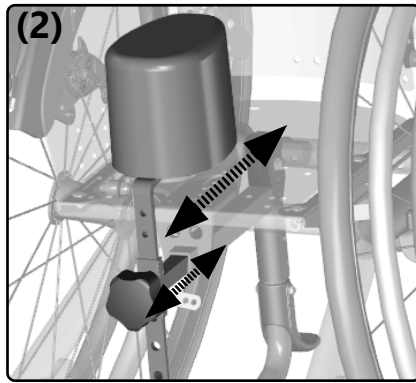
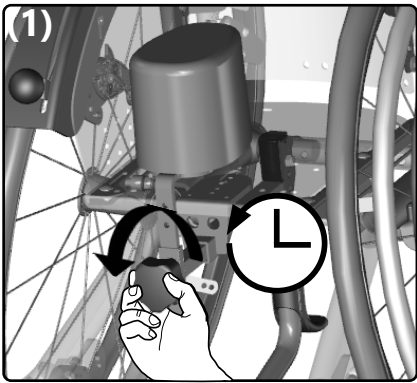

Set height:

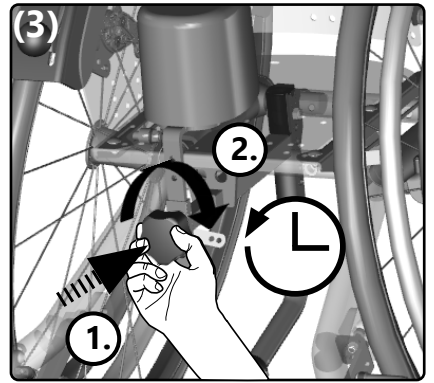
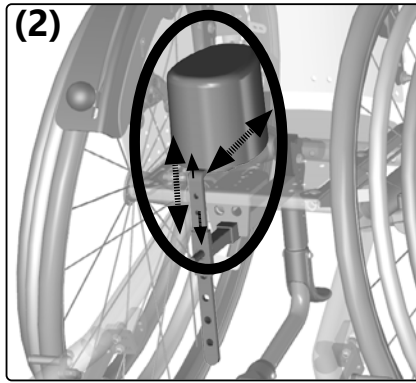
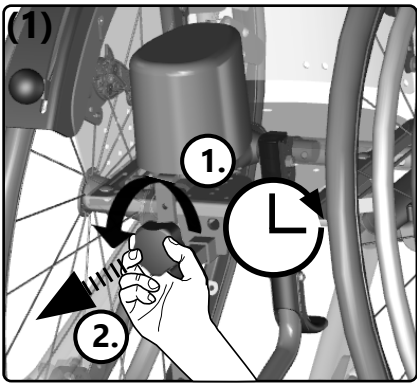

3.12 Handling therapy table

3.12.1 General information regarding therapy table

Set depth/ insert / remove:

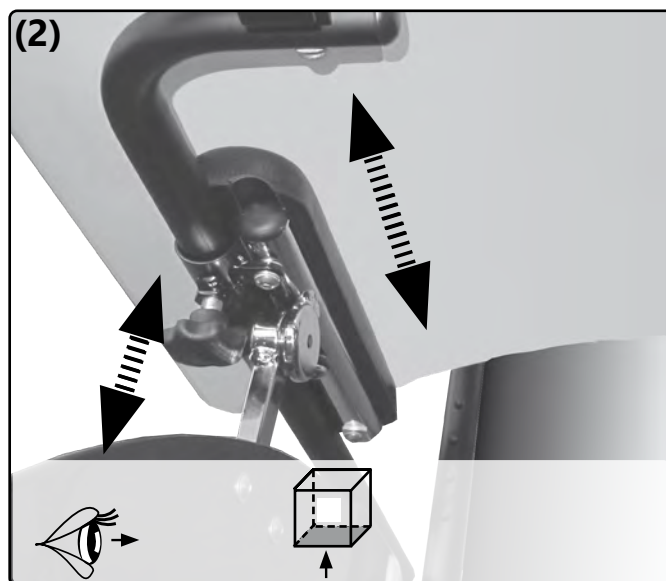

3.13 Handling lateral truss pad

3.13.1 General information regarding lateral truss pad

Open/close:

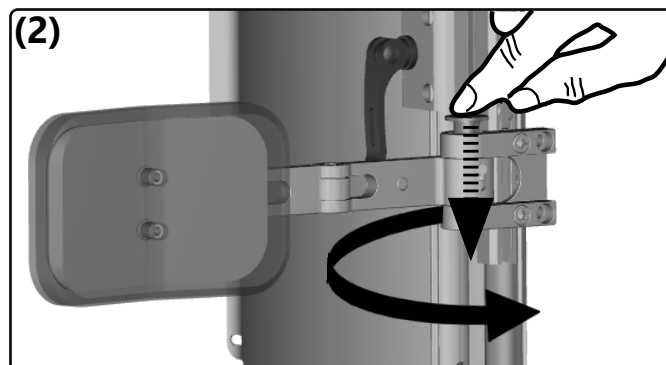
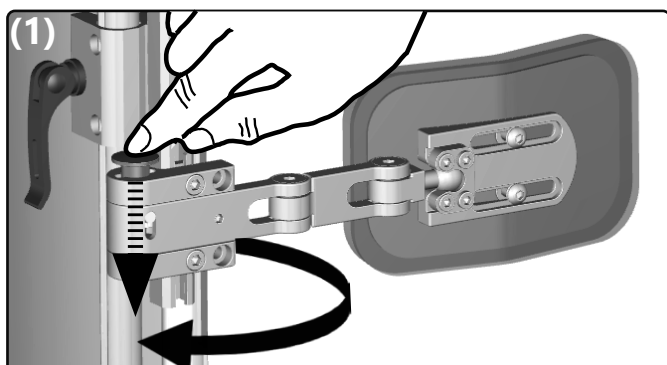

3.14 Handling steering & pushing aid

3.14.1 General information regarding steering and pushing aids

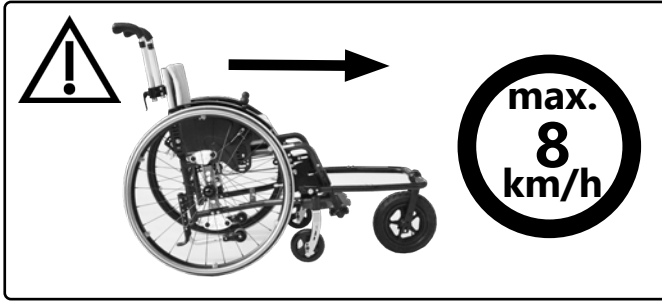

⚠ Pay attention to the max. load of the wheelchair, this also applies to the steering and pushing aid.

Mount (dismount: proceed in reverse order at Fig. 4):

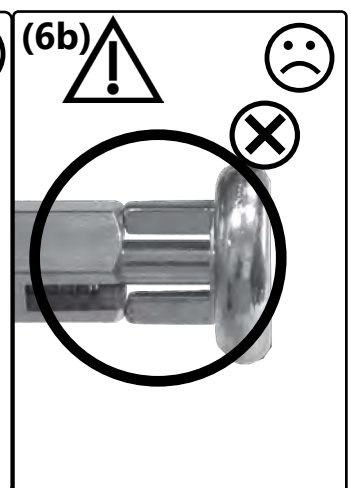
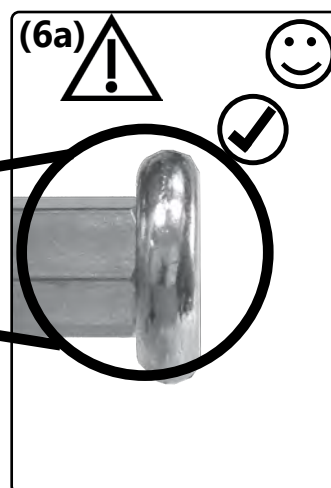
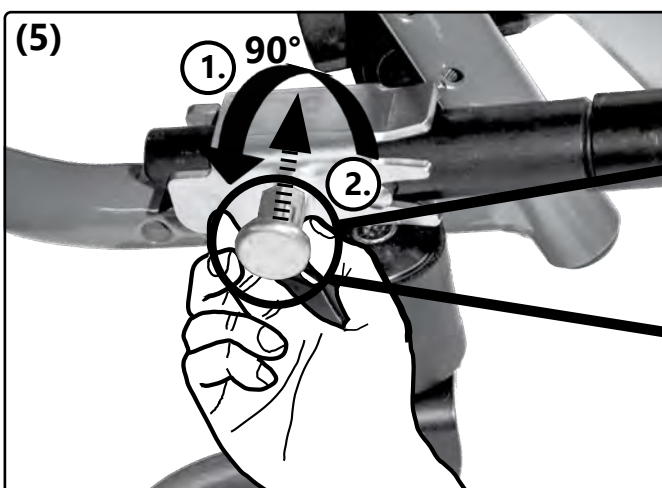
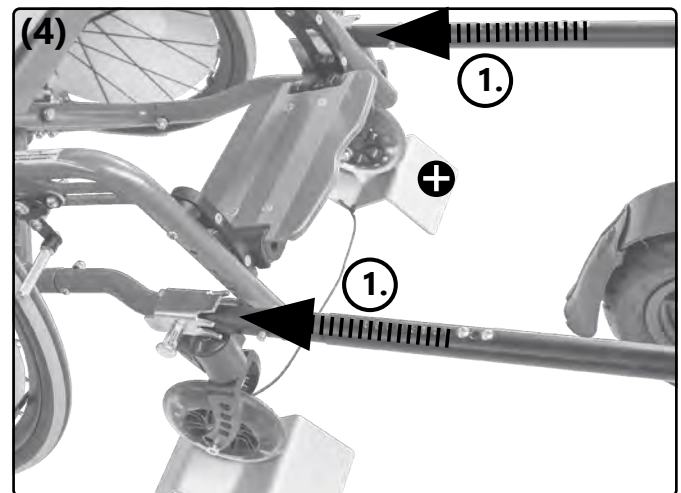
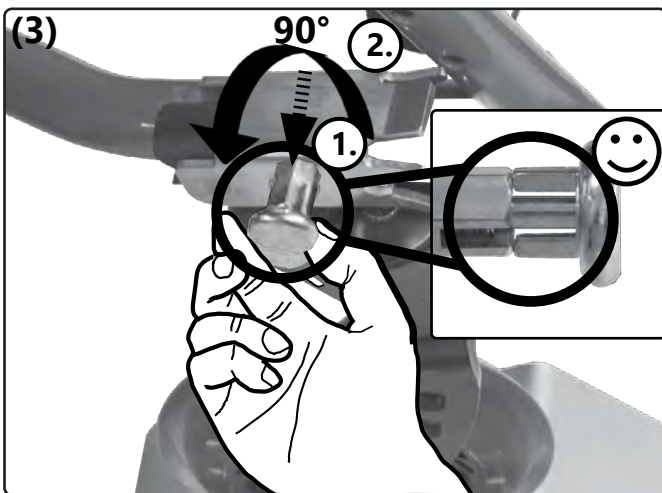
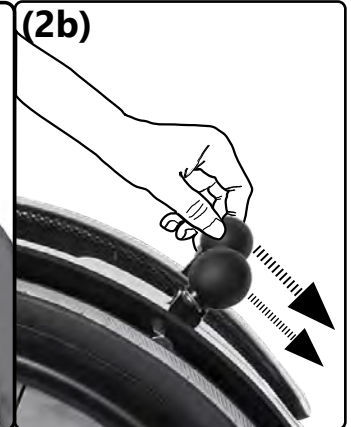
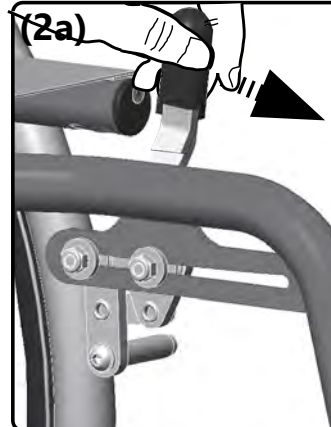

3.15 Handling one-hand steering aid

3.15.1 General information regarding one-hand steering aid

Note: Not with model Jump beta BSA

Activate (deactivate: proceed accordingly in reverse order):

The swivel casters must be set to the "straight ahead" position - this is the only way to activate or deactivate one-hand steering.

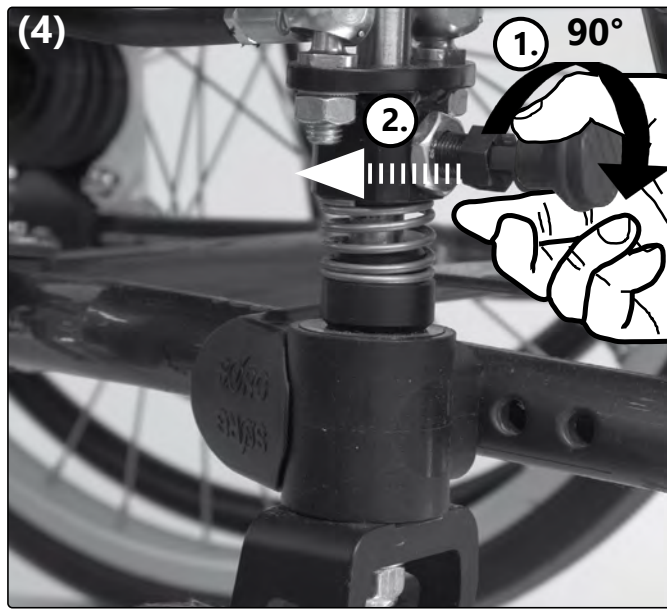
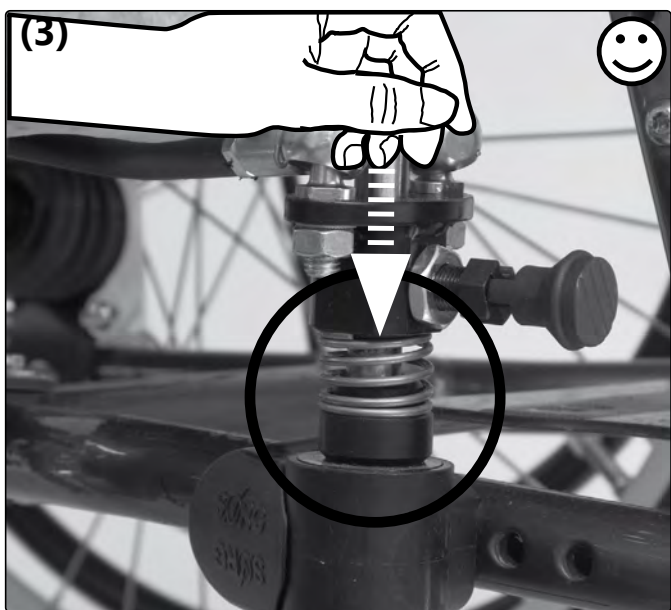
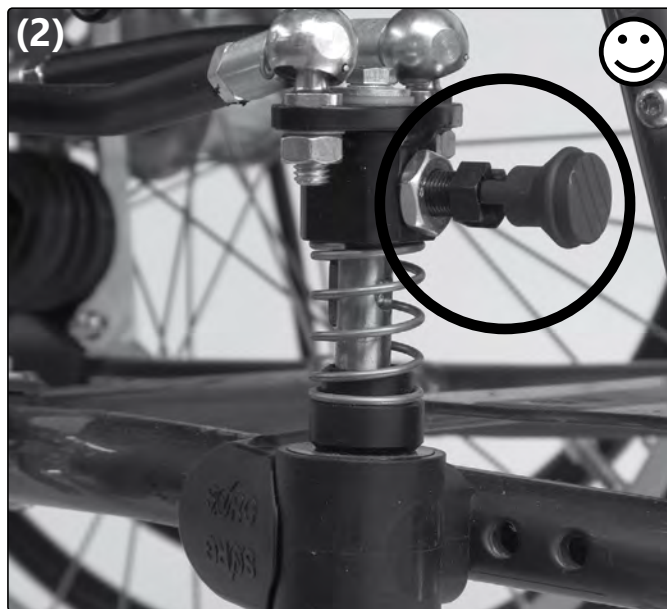
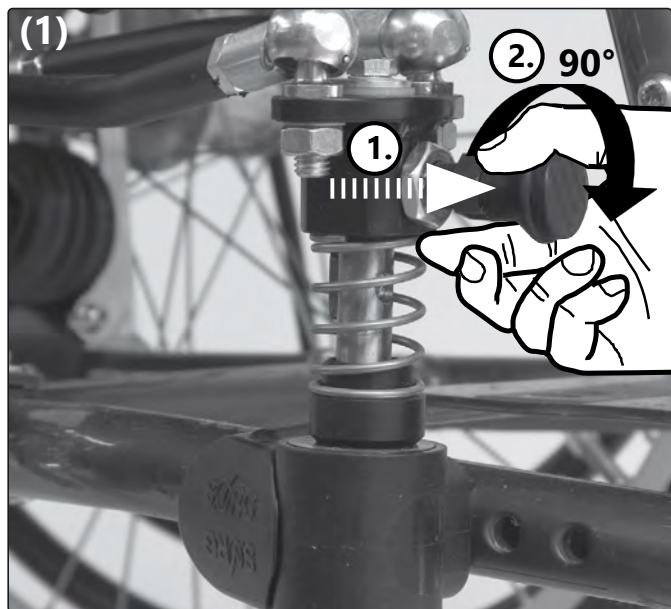

3.15 Handling one-hand steering aid

Set:

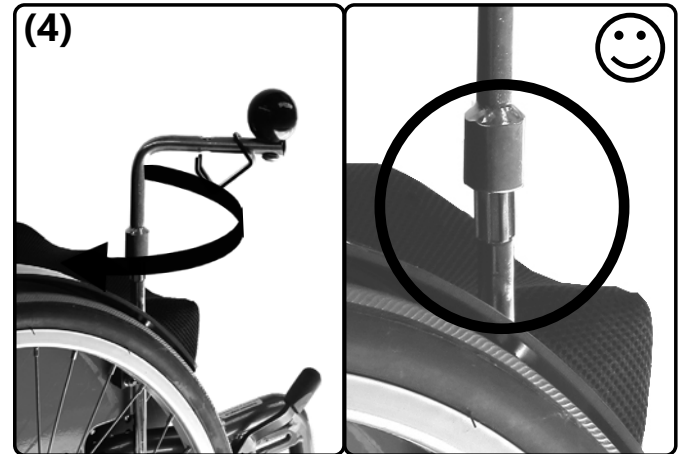
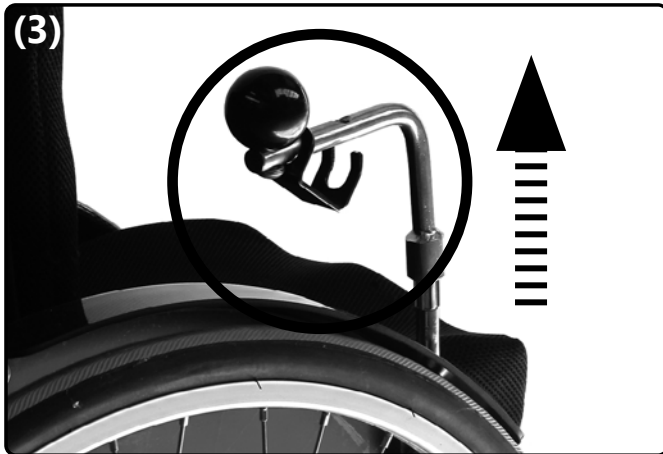
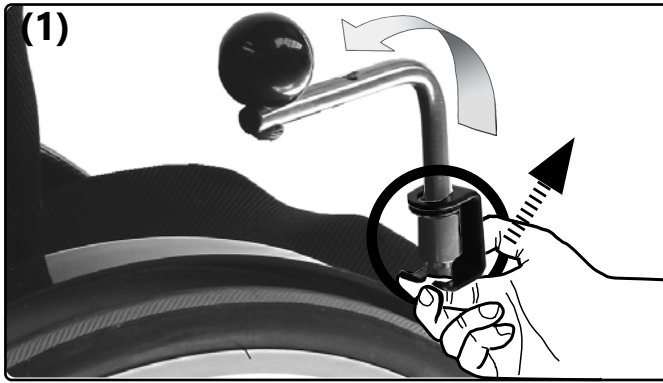

3.16 Handling sun shade

3.16.1 General information regarding sun shade

The sun shade can reach temperatures of over 42° when exposed to the sun.

Never carry the wheelchair over an obstacle using the sun shade.

It is not suitable for protection against rain.

Fold in (fold out: proceed accordingly in reverse order):

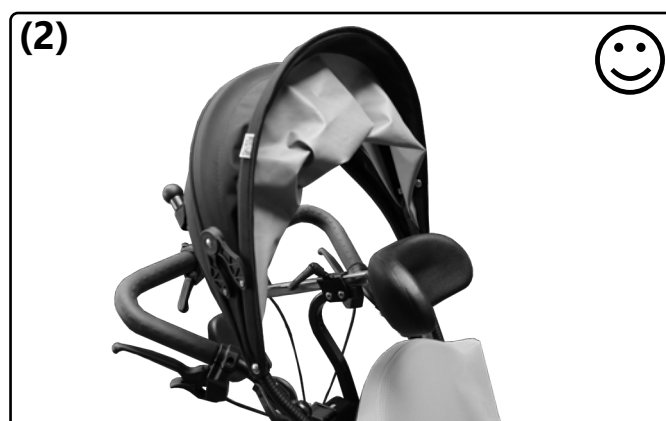

Detach (attach: proceed accordingly in reverse order):

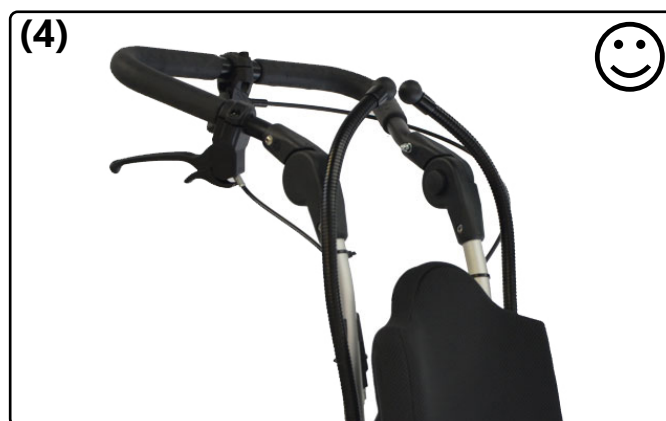
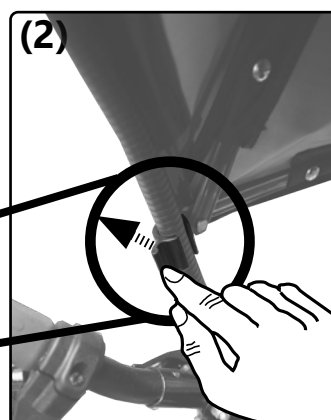
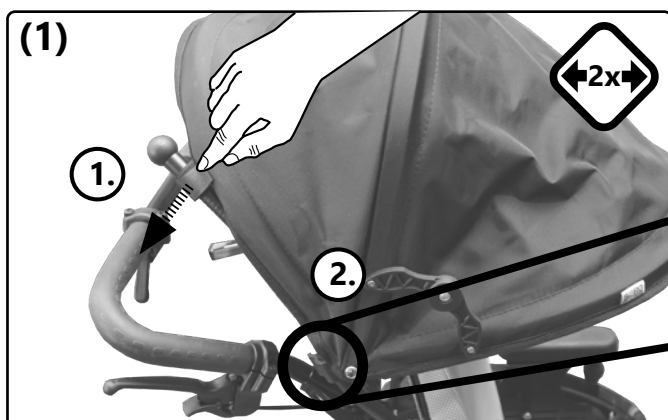

4.1 Repairs

 Repairs must only be carried out by a specialist dealer.

4.2 Spare parts

Only original replacement parts may be used. These can be obtained from your specialist dealer.

 The replacement parts list can be downloaded from www.sorgrollstuhltechnik.de or requested from us.

Please indicate the serial number of your wheelchair to ensure correct replacement part delivery. This can be found on the nameplate on the frame.

4.3 Maintenance

Regularly clean the wheelchair and all components using a mild, water-based household detergent and then dry thoroughly.

Also clean the driving and swivel casters and remove dirt and impurities (e.g. hair etc.) from the axles.

Washing textile parts:

Care instructions:

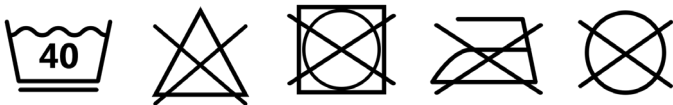

Wipe down imitation leather, belts and other upholstery:

Care instructions:



4.4 Disinfection

Cleaning must be carried out before each disinfection. Use a household water-based agent for disinfection. Please observe the application instructions of the respective manufacturer.

4.5 Storage

- Carry out cleaning
- Fold up foldable wheelchair (if applicable)
- Set (seating unit) tilt mechanism (if present) to 90°.
- Pack detachable textile parts in foil or the like, if necessary
- Secure the wheelchair against rolling away and contamination
- Storage in a dry place without aggressive environmental influences

4.6 Lifespan

The expected lifespan, depending on the intensity of use and the number of re-uses, is 5 years. For this purpose, the product must be used within the intended purpose and intended use, the instructions in the instructions for use must be followed and all maintenance and service intervals must be observed.

The product can be used beyond this period if it is in a safe condition. This theoretical lifespan is not a guaranteed lifespan and is subject to a case-by-case check by specialist retailers, as is reusability.

Use beyond the specified lifespan leads to an increase in residual risks and should only be carried out after careful and qualified consideration by the operator.

The lifespan can also be shortened depending on the frequency of use, the environment and care. The usual service life does not refer to wear parts such as textile parts, wheels and plastic parts that are subject to material-specific aging and / or wear. This specified service life does not constitute an additional guarantee or guarantee.

4.7 Reinstatement

Before reuse, a full inspection according to the checklist must be carried out by a specialized retailer. All disinfection measures for reuse must be carried out according to a validated hygiene plan.

4.8 Disposal

The wheelchair may only be disposed of with the approval of the benefactor. Disposal of the wheelchair must be in accordance with the applicable national regulations.

4.9 Maintenance/Inspection

For safety reasons and to maintain product liability, an inspection by your retailer is required at least once a year. This must be carried out and documented according to the following checklist.

Checklist maintenance and care (user)

 A poor or neglected maintenance of the wheelchair represents a significant safety risk.

Before each use:

Please check:

- frame, back tubes, mounting parts and accessories for visible damages, deflections, cracks or missing/loose screws,
- wheels/quick release axles for firm fit,
- the airpressure of the tires, tire tread,
- the function of the brakes,
- firm fit of the angle adjustments/eccentric clamps,
- firm fit of seat plate/back/foot plate,
- the function of the anti-tipper/seat and back straps,
- if all previously dismantled parts are put on again or firmly locked.

Every 3 months:

(depending on use, earlier)

Please check:

- screws for firm fitting
- welds, attachments and accessories for hidden damages, deflections or cracks
- tire tread
- the firm fit of third-party systems (if available)

Clean the wheelchair and oil all moving parts.

 If you notice any defects during maintenance, please contact your specialist retailer immediately and do not use the wheelchair anymore.

Checklist yearly inspection (specialized retailer)

Template (available for download at www.sorgrollstuhltechnik.de/downloadportal)

Preparatory Work

- cleaning done

Check:

- Frame, back, mounted parts and accessories checked for damage, bends, cracks and corrosion,
- all fixing screws checked for firm fit and completeness,
- casters and rear wheels as well as the associated attachments checked for good condition, functionality and proper running qualities,
- spokes checked for firm fit and completeness,
- brakes cleaned and maintained,
- Locking mechanisms (tripod springs of push handles, quick-release axles, eccentric clamps, etc.) checked for functionality,
- anti-tipper checked for firm fit and functionality.

Oiling:

- moving parts and bearings oiled

Final check:

- functional check of all mechanical adjusting devices carried out.

5.1 Data and measurements

Model: Jump beta (Sport/ BSA)

Type: 485

Aid index no.: 18.50.03.1079

All measurements ±5%

Designation		Dimensions	Remarks
Seat width (SW)	Sport frame BSA frame XL frame	300-500 mm 300-500 mm 380-500 mm	optional per SW + max. 20 mm growable
Seat depth (SD) in 20 mm increments	Sport frame BSA frame XL frame	340-500 mm 340-500 mm 440-540 mm	optional per SD + max. 40 mm growable
Back height (BH) in 50 mm increments		250-500 mm	can be displaced vertically by 25 or 50 mm respectively
Upper edge (UE) seat to upper edge (UE) footrest	Indoor attachment Outdoor attachment XL indoor attachment XL outdoor attachment	45-325 mm 315-480 mm 85-360 mm 355-520 mm	The lower leg length (LLL) is the distance from: UE seat to UE footrest PLUS thickness of the seat cushion.
Frame length 4	Sport frame	574 mm	
Frame size 5	Sport frame BSA frame	594 mm 615 mm	
Frame size XL	Sport frame BSA frame	635 mm 661 mm	
ETRTO wheel size 22"		Ø 25-489	Conventional pneumatic tyres in sizes 1" (25.4 mm), 1 3/8" (35 mm) - sizes 489 mm (22"), 540 mm (24"), 590 mm, (26"). All puncture-proof tyres in the specified dimensions.
ETRTO wheel size 24"		Ø 25-540	
ETRTO wheel size 26"		Ø 28-590	
Handrim diameter		Ø 19 mm	Tube diameter
	22"	Ø 481 mm	
	24"	Ø 533 mm	
	26"	Ø 585 mm	
Caster wheels	Polyurethane, pneumatic, solid rubber, LED	4", 5", 5.5", 6", 7"	
Camber		0°, 2°, 5°, 8°	
Back angle:	Setting Standard 90°	possible from 80° to 105°	
	Adjustment with raster/gas pressure	possible from 80° to 120°	
Seat height (SH) front	min.	415 mm	The seat heights are measured from the upper edge of the seat to the floor, WITHOUT seat cushions! Info: The seat-surface inclination can vary by 0-10° at the rear.
Seat height (SH) front	max.	575 mm	
Seat height (SH) rear	min.	340 mm	
Seat height (SH) rear	max.	580 mm	
Width wheelchair absolute	min	SW + 200 mm	Dependent on the camber, the selected tyres and the mounting of the handrims
Width wheelchair absolute	max.	SW + 405 mm	
Width wheelchair folded	min. max.	290 mm 350 mm	
Length wheelchair absolute	Sport	min. 835 mm max. 970 mm	With an outdoor front end, the dimension is extended in line with the front end. The driving wheel position can be adjusted horizontally by up to 60 mm on the axle plate/frame.
	XL Sport	min. 915 mm max. 1040 mm	
Length wheelchair absolute	BSA	min. 875 mm max. 990 mm	
	XL BSA	min. 940 mm max. 1065 mm	
Height wheelchair absolute	Sport	min. 790 mm max. 1055 mm	Measured with standard push handles. With height-adjustable push handles, the dimension changes in line with the adjustment.
	XL Sport	min. 790 mm max. 1055 mm	
Height wheelchair absolute	BSA	min. 855 mm max. 1120 mm	
	XL BSA	min. 855 mm max. 1120 mm	
Permissible incline/ downward gradient/ resistance to tilting		12.3% = 7°	
Turn radius	approx. 1000 mm	dependent on the wheelchair size	
Load (max.)		120 kg	
Empty weight min. fit for use = SW 440 mm, 24" driving wheels, 5" polyurethane swivel casters		14.6 kg	Frame, side guards, driving and caster wheels, leg supports, back and seat cover, brakes
Individual weights	Driving wheels / frame	1.2 – 2 kg/ 8 kg	depending on size and design
Tyres	Conventional pneumatic tyres, sizes 1" or 1 3/8" or puncture proof tyres (same dimensions), tyre pressure usually 3-10 bar		
Usage life	3 years	in case of non-excessive strain	
Service life	5 years		
Normative requirements	The wheelchair complies with the requirements of ISO 7176-8 and the requirements against ignition.		
Weight test dummy	120 kg		

5 Technical data

5.2 Meaning of labels

The meaning of the individual labels can be directly derived from the text at the corresponding position.

A new nameplate can be obtained from SORG Rollstuhltechnik if the original one is lost or damaged.

Type plate:

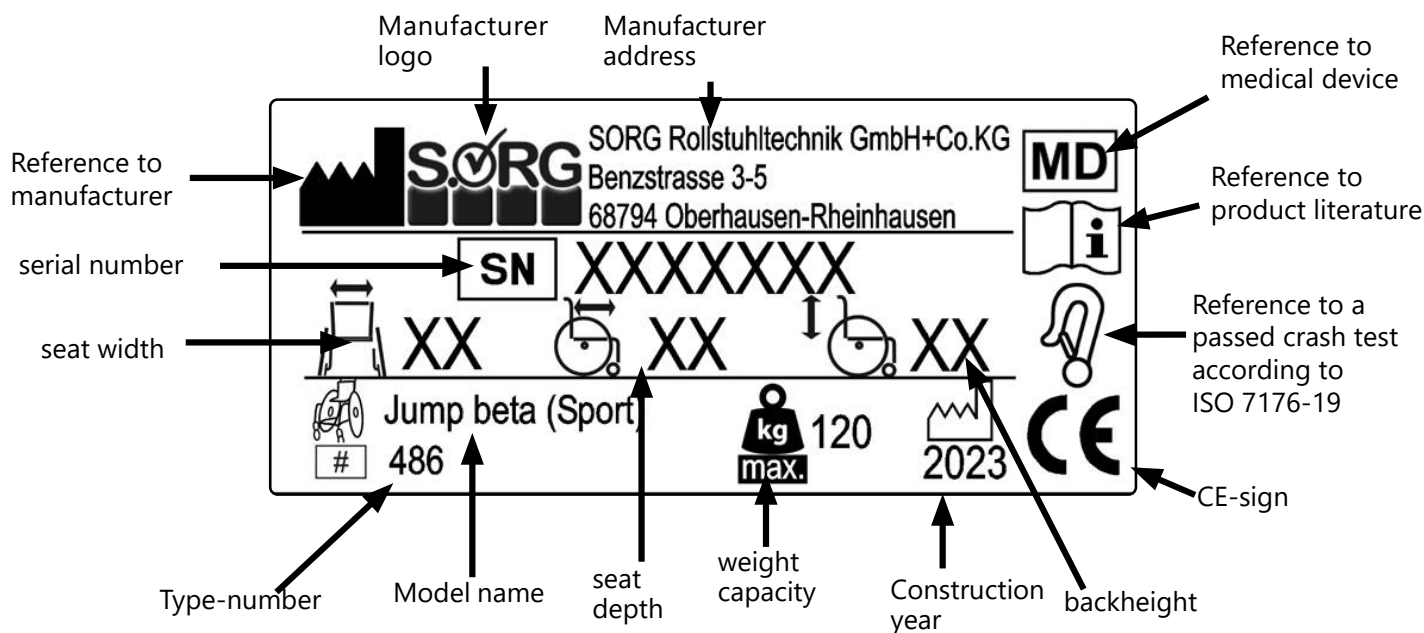

5.3 Declaration of conformity

SORG Rollstuhltechnik declares that the product Jump beta (BSA or Sport-frame) class 1 device is and it complies with the EU regulation (EU) 2017/745 on medical devices.

This was confirmed by a conformity assessment procedure according to the medical Product Guideline.

If the product is not modified with SORG wheelchair technology, this declaration will lose its validity.



6 Verification of yearly inspection

Documentation yearly inspection

An inspection must be carried out by your specialist dealer at least once a year for safety reasons and to preserve the product warranty.

Serial number: _____

- yearly inspection conducted according to check list (operating year 1)

Remarks:

Stamp:

 Date/ Retailer's signature

- yearly inspection conducted according to check list (operating year 2)

Remarks:

Stamp:

 Date/ Retailer's signature

- yearly inspection conducted according to check list (operating year 3)

Remarks:

Stamp:

 Date/ Retailer's signature

- yearly inspection conducted according to check list (operating year 4)

Remarks:

Stamp:

 Date/ Retailer's signature

- yearly inspection conducted according to check list (operating year 5)

Remarks:

Stamp:

 Date/ Retailer's signature

Instructions for use Jump beta



SORG Rollstuhltechnik GmbH + Co. KG
Benzstrasse 3-5
68794 Oberhausen-Rheinhausen / Germany
Germany
Phone +49 7254 9279-0
Fax +49 7254 9279-10

info@sorgrollstuhltechnik.de
www.sorgrollstuhltechnik.de

Company stamp