



## Mobile standing device for children and adolescents

(User height max. 150cm)

### Included in the base price:

- Frame width grows +4cm
- Puncture proof tyres
- Centre column tiltable forward 0° -15°
- Standard knee truss pads with kneecap cut-out
- Posterior and chest truss pads
- Also included: Drum brakes; height adjustable and lockable caster and support wheels in back; 1 or 2 casters in front; Standard foot plates

Quotation

Order

German aid index N°: 28.29.01.3010  
Weight capacity: 60 kg

**Base price from 3.050,- €**

Prices excl. VAT,  
valid from 15.01.2024 and until further notice.

<b>Delivery address / Company stamp:</b>		<b>Billing address:</b> <input type="checkbox"/> same as delivery address	
Name:		Name:	
Address:		Address:	

<b>Ordering information:</b>	
Reference/ internal description:	Date:
Contact person:	Signature:

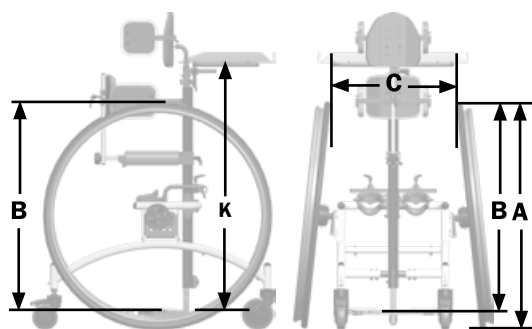
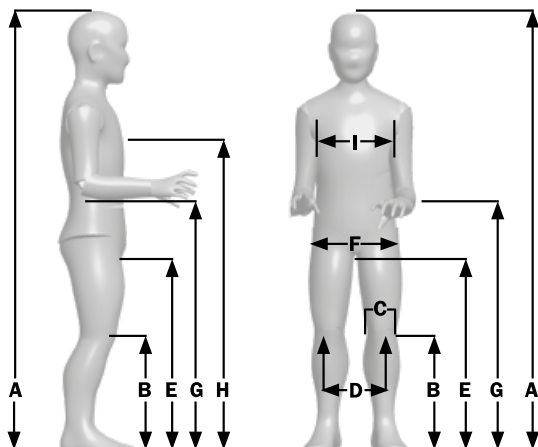

We mount the mobile standing device according to your information		Please do not use measuring tape for your measurements, but rather a meter. Please measure:
<b>A</b>	<b>body height:</b> _____ cm	from the shoe sole to the parting
<b>B</b>	<b>knee height:</b> _____ cm	from the shoe sole to the middle of the kneecap
<b>C</b>	<b>knee width:</b> _____ cm	the widest part of the knee
<b>D</b>	<b>knee distance:</b> _____ cm	the distance between the middle of both kneecaps
<b>E</b>	<b>crotch height:</b> _____ cm	from the shoe sole to the crotch
<b>F</b>	<b>pelvis width:</b> _____ cm	the widest part of the pelvis (trochanter major)
<b>G</b>	<b>elbow height:</b> _____ cm	from the shoe sole to the bottom edge of the elbow
<b>H</b>	<b>sternum height:</b> _____ cm	from the shoe sole to the middle of the sternum
<b>I</b>	<b>chest width:</b> _____ cm	the width of the ribcage at the height of the armpits
<b>K</b>	<b>table height</b> _____ cm	from the shoe sole to the desired arm rest height (mostly higher than the height of „G“)

Frame Size		Size 1			Size 2			Size 3		
<b>body height</b>		80-110 cm			100-130 cm			120-150 cm		
<b>A</b>	<b>wheel size</b>	24"x1" ø 58 cm	26"x1" ø 63 cm	28"x1" ø 68 cm	28"x1" ø 68 cm	30"x1" ø 75 cm	32"x1" ø 80 cm	36"x1" ø 90 cm		
<b>recommended at elbow height</b>		47 cm	52 cm	57 cm	57 cm	64 cm	69 cm	81 cm		
<b>B</b>	<b>foot plate to top of hand rim</b>	39-47 cm	44-52 cm	49-57 cm	49-57 cm	56-64 cm	61-69 cm	71-79 cm		
<b>C</b>	<b>upper distance between both wheels with camber:</b>	0°						58 cm	58 cm	
		3°	44 cm	44 cm	43 cm	55 cm	54 cm	54 cm	55 cm	54 cm
		6°	42 cm	41 cm	40 cm	52 cm	50 cm	50 cm	51 cm	49 cm
		9°	40 cm	38 cm	37 cm	49 cm	47 cm	46 cm	48 cm	45 cm
		12°	37 cm	35 cm	33 cm	46 cm	44 cm	42 cm		

Frame Sizes (grow 4 cm)			
<b>Base price</b>	<b>3.050,- €</b>	<b>Base price</b>	<b>3.380,- €</b>
<b>for body height 80-110 cm,</b> <input type="checkbox"/> frame width 36 cm (+4cm), <input type="checkbox"/> pre-assembled to 40 cm  one caster in front, two sprung casters in back, possible wheel sizes 24", 26", 28"		<b>for body height 100-130 cm,</b> <input type="checkbox"/> frame width 40 cm (+4cm) <input type="checkbox"/> pre-assembled to 44 cm  one caster in front, two sprung casters in back, possible wheel sizes 28", 30", 32"	<b>for body height 120-150 cm,</b> <input type="checkbox"/> frame width 44 cm (+4cm) <input type="checkbox"/> pre-assembled to 48 cm  two caster in front, two sprung casters in back, possible wheel sizes 32", 36"
<b>Size 1</b>	<b>N° 5901</b>	<b>Size 2</b>	<b>N° 5902</b>
		<b>Size 3</b>	<b>N° 5903</b>

Frame colors			
<b>Coating options</b>	<b>Moderate metallic effect</b>	<b>Not metallic</b>	<b>Special colors (without additional charge, except for Nightblue)</b>
<input type="checkbox"/> shiny  <b>0,- €</b>  <input type="checkbox"/> dull (not possible with special colors!)	<input type="checkbox"/> Cream white (17) <input type="checkbox"/> Zinc yellow (02) <input type="checkbox"/> Chrome yellow (06) <input type="checkbox"/> Pure Orange (21) <input type="checkbox"/> Crimson (04) <input type="checkbox"/> Girly Pink (19) <input type="checkbox"/> Pastel Blue (20)	<input type="checkbox"/> Brilliant Blue (08) <input type="checkbox"/> Dark Blue (16) <input type="checkbox"/> Dark Green (15) <input type="checkbox"/> Goblin Green (33) <input type="checkbox"/> Titan Grey (34) <input type="checkbox"/> King's Blue (32)	<input type="checkbox"/> Black (31)  <b>strong metallic effect:</b> <input type="checkbox"/> Silver Metallic (36)  <b>coarse structured surface:</b> <input type="checkbox"/> Coarse Black (27)
<b>N° 1561</b>	<b>90,- €</b>		<b>Dormant colors:</b> <input type="checkbox"/> Firered (45) <input type="checkbox"/> Violet (50)  <b>Dormant color with AC:</b> <input type="checkbox"/> Nightblue (47) <b>AC 90,- €</b>
Truss pad covers (synthetic leather)			
<b>Colors (N° 15..)</b>	<input type="checkbox"/> Black (90) <input type="checkbox"/> Firered (92) <input type="checkbox"/> Violet (93) <input type="checkbox"/> Turquoise (94) <input type="checkbox"/> Powder Blue (95) <input type="checkbox"/> Lime (96) <input type="checkbox"/> Green (97)		

Driving wheels		Hand rim covers	
	<b>Profile wheels with built-in hand rim and drum brakes, puncture proof polyurethane tyres.</b>  <b>wheel size   suitable for frames</b> 24"   Size: <b>1</b> 26"   Size: <b>1</b> 28"   Size: <b>1+2</b> 30"   Size: <b>2</b> 32"   Size: <b>2+3</b> 36"   Size: <b>3</b>	<b>Ergonomic cover, 13 mm wide,</b> Filling between the tyre and the hand rim.	<b>Silicone cover</b> removable.
<b>Price</b>	<b>Price/Pair</b>	<b>Price/Pair</b>	<b>Price/Pair</b>
<b>camber for frames</b> <input type="checkbox"/> 0° (...00) Size: <b>3</b> <b>incl.</b> <input type="checkbox"/> 3° (...03) Size: <b>1-3</b> <b>incl.</b> <input type="checkbox"/> 6° (...06) Size: <b>1-3</b> <b>incl.</b> <input type="checkbox"/> 9° (...09) Size: <b>1-3</b> <b>incl.</b> <input type="checkbox"/> 12° (...12) Size: <b>1+2</b> <b>incl.</b> 6° default if no value is specified  <b>N° 2059..</b>	<input type="checkbox"/> 24" N° 222442   <b>260,- €</b> <input type="checkbox"/> 26" N° 222642   <b>260,- €</b> <input type="checkbox"/> 28" N° 222842   <b>300,- €</b> <input type="checkbox"/> 30" N° 223042   <b>300,- €</b> <input type="checkbox"/> 32" N° 223242   <b>350,- €</b> <input type="checkbox"/> 36" N° 223642   <b>430,- €</b>	<input type="checkbox"/> 24" N° 3624   <b>198,- €</b> <input type="checkbox"/> 26" N° 3626   <b>216,- €</b> <input type="checkbox"/> 28" N° 3628   <b>224,- €</b> <input type="checkbox"/> 30" N° 3630   <b>236,- €</b> <input type="checkbox"/> 32" N° 3632   <b>236,- €</b> <input type="checkbox"/> 36" N° 3636   <b>236,- €</b>	<input type="checkbox"/> 24" N° 3724   <b>156,- €</b> <input type="checkbox"/> 26" N° 3726   <b>190,- €</b>

Standard spoke cover	Decor spoke cover
transparent, colorless	<input type="checkbox"/> 24" <input type="checkbox"/> 26"  Model-N°: _____ from <a href="http://www.speichen-schutz.de">www.speichen-schutz.de</a>
<b>Price/Pair</b>	<b>N° 25..26 TD 180,- €/P</b>
<input type="checkbox"/> 24" (N° 252400)   <b>168,- €</b> <input type="checkbox"/> 26" (N° 252600)   <b>188,- €</b> <input type="checkbox"/> 28" (N° 252800)   <b>188,- €</b> <input type="checkbox"/> 30" (N° 253000)   <b>268,- €</b> <input type="checkbox"/> 32" (N° 253200)   <b>268,- €</b> <input type="checkbox"/> 36" (N° 253600)   <b>268,- €</b>	<input type="checkbox"/> 24" <input type="checkbox"/> 26"  Model-N°: _____ from <a href="http://www.wheelchairgadgets.com">www.wheelchairgadgets.com</a>
	<b>N° 25..27 TD 180,- €/P</b>

Chest truss pad		
	<p><b>Chest truss pads</b> stepless adjustment in height and in tilting angle. Incl. safety belt</p> <ul style="list-style-type: none"> <li><input type="checkbox"/> <b>Size 1</b> N° 683101 Padsizes: 16x17 cm (WxH)</li> <li><input type="checkbox"/> <b>Size 2</b> N° 683102 Padsizes: 22x22 cm (WxH)</li> <li><input type="checkbox"/> <b>Size 3</b> N° 683103 Padsizes: 29x27cm (WxH)</li> </ul>	<p><b>Side chest truss pads</b> stepless adjustment in width and depth. Incl. safety belt</p> <ul style="list-style-type: none"> <li><input type="checkbox"/> <b>Size 1</b> chest width 16-24 cm N° 684301, padsizes 9x9cm (WxH)</li> <li><input type="checkbox"/> <b>Size 2</b> chest width 22-32 cm N° 684302, padsizes 12x12cm (WxH)</li> <li><input type="checkbox"/> <b>Size 3</b> chest width 28-42 cm N° 684303, padsizes 12x12cm (WxH)</li> </ul>
	<b>0,- €</b>	<b>245,- €</b>

Posterior truss pad standard		
	<p><b>Posterior truss pad</b> stepless height adjustment, incl. crotch truss pad</p> <ul style="list-style-type: none"> <li><input type="checkbox"/> <b>Size 1</b> pelvis depth 13-22cm N° 684201, padsizes 16x16cm (WxH)</li> <li><input type="checkbox"/> <b>Size 2</b> pelvis depth 18-31,5cm N° 684202, padsizes 22x18cm (WxH)</li> <li><input type="checkbox"/> <b>Size 3</b> pelvis depth 18-31,5cm N° 684203, padsizes 30x19,5cm (WxH)</li> </ul>	<p><b>Side posterior truss pads</b> stepless adjustment in width and depth.</p> <ul style="list-style-type: none"> <li><input type="checkbox"/> <b>Size 1</b> pelvis width 16-24 cm N° 684211, padsizes 9x9cm (WxH)</li> <li><input type="checkbox"/> <b>Size 2</b> pelvis width 22-32 cm N° 684212, padsizes 12x12cm (WxH)</li> <li><input type="checkbox"/> <b>Size 3</b> pelvis width 28-42 cm N° 684213, padsizes 12x12cm (WxH)</li> </ul> <p><b>Not possible in combination with side pelvis truss pads</b></p>
	<b>0,- €</b>	<b>240,- €/P</b>

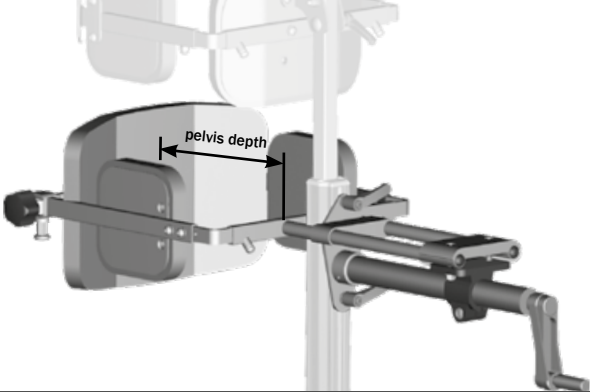
Posterior truss pad with crank		
	<p><b>Posterior truss pad with crank</b> and swivel bracket, for stepless raising in the pelvic area, crank operable from the front and removable, incl. side posterior truss pads.</p> <p><b>The back truss pad and the side pelvis truss pad are not possible.</b></p>	<ul style="list-style-type: none"> <li><input type="checkbox"/> <b>Size 1</b> N° 684221 pelvis width 18-26cm pelvis depth 13-24cm posterior truss pad: 16x16cm (WxH) side posterior truss pads: 9x9cm (WxH)</li> <li><input type="checkbox"/> <b>Size 2</b> N° 684232 pelvis width 23-36cm pelvis depth 18-32cm posterior truss pad: 22x18cm (WxH) side posterior truss pad: 12x12cm (WxH)</li> <li><input type="checkbox"/> <b>Size 3</b> N° 684242 pelvis width 29-42 cm pelvis depth 18-32cm posterior truss pad: 30x19,5cm (WxH) side posterior truss pad: 12x12cm (WxH)</li> </ul>
		<b>490,- €</b>

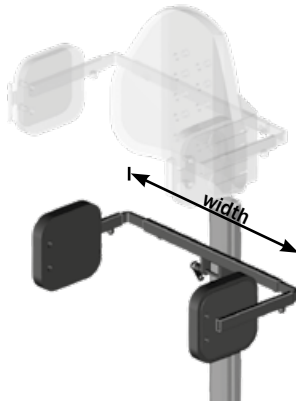
Side pelvis truss pad and back truss pad		
	<p><b>Side pelvis truss pad</b> stepless adjustment in width, height and depth</p> <ul style="list-style-type: none"> <li><input type="checkbox"/> <b>Size 1</b> N° 684401 pelvis width 16-24cm Padsizes 9x9cm (WxH)</li> <li><input type="checkbox"/> <b>Size 2</b> N° 684402 pelvis width 22-32cm Padsizes 12x12cm (WxH)</li> <li><input type="checkbox"/> <b>Size 3</b> N° 684403 pelvis width 28-42cm Padsizes 12x12cm (WxH)</li> </ul> <p><b>Not possible in combination with posterior truss pad with crank OR side posterior truss pads</b></p>	<p><b>Back truss pad</b> with swivel bracket frame</p> <ul style="list-style-type: none"> <li><input type="checkbox"/> <b>Size 1</b> N° ..05 Pad size 12x16 cm (WxH)</li> <li><input type="checkbox"/> <b>Size 2</b> N° ..06 Pad size 16x19 cm (WxH)</li> </ul> <p><b>Only in combination with side chest truss pads (N° 6843..)</b></p>
	<b>245,- €</b>	<b>260,- €</b> N° 6848..

### Front pelvic truss pad

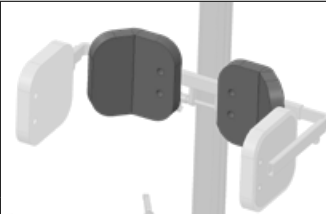

**Front pelvic truss pad** two-part, for mounting on pelvis truss pad or posterior truss pad with crank. *Selection of pelvis truss pad or posterior truss pad is necessary.*

**Front pelvic truss pad size 1** (...01)  
 Pad size 9x10cm only with selection pelvis-/posterior truss pad size 1

**Front pelvic truss pad size 2** (...02)  
 Pad size 13x13cm only with selection pelvis-/posterior truss pad size 2 or 3

**Only in combination with compatible pelvis truss pad or posterior truss pad with crank**

N° 6847.. **199,- €**

### Knee truss pads



**Standard knee truss pad** with knee-cap cut-out, stepless, 3-dimensional setting, individual width setting.

**Size 1** (...01) knee width 4,5-7,5 cm

**Size 2** (...02) knee width 6-11 cm

N° 683601/02 **0,- €**

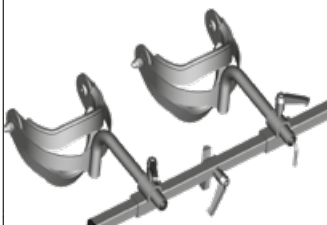

**Knee truss pad with resting brackets** individual, stepless, 3-dimensional adjustment, also recommended for Foot plate 3-dimensional angle

**Size 1** (...11) knee width 6,5 cm

**Size 2** (...12) knee width 8,5 cm

**Size 3** (...13) knee width 10,5 cm

N° 6836.. **138,- €/P**

### Foot plate

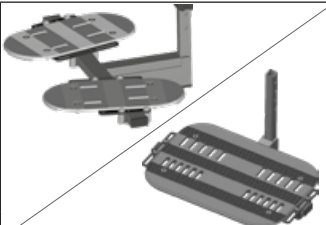

**Standard foot plates**

**Divided standard** (...400) individually abductable, adjustable in height and width and can be turned horizontally.

**Undivided Standard** (...600) adjustable in height

N° 408... **0,- €**

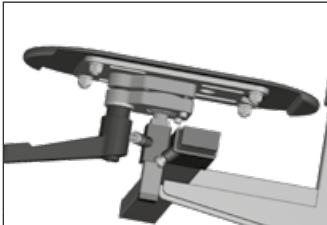

**Foot plate 3-dimensional angle adjustment** can be set individually in all directions, as well as in the tilting angle, the abduction, height and width and can be turned horizontally.

**The maximum possible body size decreases by 3 cm**

N° 408500 **255,- €/P**

### Tilting adjustment of centre column

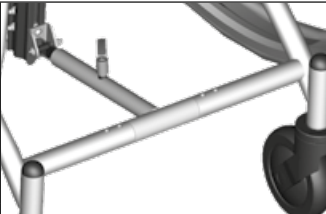

**Tilting adjustment mechanically with telescope**  
 Mechanical angle adjustment of the centre column with telescope and clamp lever.  
**(only adjustable without user)**

N° 570301 **0,- €**

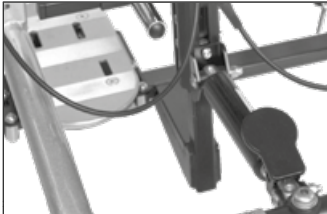



**Tilting adjustment with gas pressure spring**  
 Angle adjustment with gas pressure spring and foot pedal.  
**(adjustable with user)**

N° 570201 **190,- € AC**

### Therapy tables

Transparent therapy table with framed edge				Therapy table with toy box (the toy box is with lid)			
table Size	width	depth		table Size	width	depth	
<input type="checkbox"/> Size 0 (...21)	39 cm	30 cm		<input type="checkbox"/> Size 0 (...31)	39 cm	30 cm	
<input type="checkbox"/> Size 1 (...22)	45 cm	30 cm		<input type="checkbox"/> Size 1 (...32)	45 cm	30 cm	
<input type="checkbox"/> Size 2 (...23)	59 cm	38 cm		<input type="checkbox"/> Size 2 (...33)	59 cm	38 cm	
N° 9206.. <span style="float: right;"><b>325,- €/Pcs</b></span>				N° 9206.. <span style="float: right;"><b>AC 395,- €</b></span>			

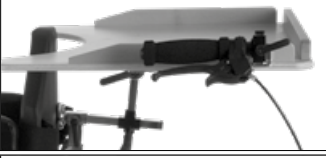
### Accessories

<input type="checkbox"/> <b>Hand brake lever</b> Holder fixated on therapy table   N° 355901 <span style="float: right;"><b>0,- €</b></span>	<input type="checkbox"/> <b>additional holder for hand brake lever</b> fixated on the centre column, height adjustable   <b>This holder is necessary, when a therapy table has NOT been chosen.</b> N° 355902 <span style="float: right;"><b>58,- € AC</b></span>	<input type="checkbox"/> <b>clamp lever</b> Instead of screws, for easier adjustment of the truss pads, especially useful for frequent adjusting of the mobile standing device.  N° 570210 <span style="float: right;"><b>79,- € AC</b></span>  <input type="checkbox"/> <b>Belts for foot shells</b>  N° 402015 <span style="float: right;"><b>104,- €/P</b></span>	<b>Foot shell</b> shell for _____ max. shoe width <input type="checkbox"/> <b>Size 1</b> (...11) 6,5 cm <input type="checkbox"/> <b>Size 2</b> (...12) 8,5 cm <input type="checkbox"/> <b>Size 3</b> (...13) 9,5 cm N° 4020.. <span style="float: right;"><b>98,- €/P</b></span>  <b>Leg length compensation</b> for divided standard foot plates (N° 408400) <b>Foot plate increased on one side:</b> Side: <input type="checkbox"/> left <input type="checkbox"/> right <b>Difference:</b> <input type="checkbox"/> 1 cm <input type="checkbox"/> 1,5 cm <input type="checkbox"/> 2 cm <input type="checkbox"/> 2,5 cm <input type="checkbox"/> 3 cm N° 408410 <span style="float: right;"><b>30,- €/Set</b></span>
---	---	---	--

**Abbreviations:**  
piece - pcs  
pair - P  
Trade discount - TD  
configuration - cf.

seat width - SW  
seat depth - SD  
back height - BH

lower leg length - LLL  
customized product discount - CPD  
Additional charge - AC

**Abbreviations:**

piece - pcs	seat width - SW	lower leg length - LLL
pair - P	seat depth - SD	customized product discount - CPD
Trade discount - TD	back height - BH	Additional charge - AC
configuration - cf.		

## Terms and conditions

### 1. Preface and Scope

(1) Our terms and conditions apply exclusively. Any deviating, opposing, or complementing terms and conditions on the part of the business partner do not form integral part of contract unless explicitly approved of by us. There are no exceptions to the consent requirement, which also applies in cases where we conduct deliveries without restrictions while aware of the business partner's terms and conditions.

(2) Agreements made in the individual case with the purchaser (including side-agreements, supplements, and alterations) always take priority over these terms and conditions. A contract or our confirmation - both in written form - are authoritative for the content of such arrangements.

(3) Any legally relevant declarations and notifications the purchaser submits to us after conclusion of the contract (e.g. setting of deadlines, notice of defects, declarations of rescission or abatement) require the written form to be valid.

(4) Any information on the application of legal regulations serves the mere purpose of clarification. All regulations are legally binding without any such clarifications unless explicitly altered or excluded in these terms and conditions.

### 2. Prices

All prices are ex works, excluding insurance and packaging. The prices are net prices; the value-added tax is stated and charged separately according to the legally binding rate at the time of invoicing. The prices valid on the day of delivery are binding unless explicitly arranged otherwise.

### 3. Conclusion of Contract

SORG's offers are invitatio ad offerendum (invitations to treat). Ordering goods counts as an obligatory offer of contract on the part of the purchaser. Unless the order suggests otherwise, we have the right to accept this contract offer within two weeks time after reception. The acceptance of an offer of contract is effected by the confirmation of the order.

### 4. Terms of Payment

(1) Provided that no other agreements exist, payment is to be made by paying in advance - 50% at placing of order, 50% pre-delivery of goods. The purchaser bears any costs arising from transactions or discounting.

(2) If a 30-day payment deadline is exceeded, a delay rate of 9% on top of the respective base rate of the European Central Bank falls due without the need for prior notices. Beyond that, the purchaser is charged 3,- € for any reminder sent. We reserve the right to make use of the commercial due rate according to § 353 HGB. A higher damage for delay may be enforced via a suitable verification.

### 5. Offers and Validity

All current price lists are generally valid until December 31. of the respective year, or until new price lists are published. The latest version of the price list will always be provided on our homepage. Offers older than 3 months at that point expire and must be replaced with new offers and prices.

### 6. Time of Delivery and Delay

We state the terms of delivery when accepting the order. The delivery date is non-binding and has mere guideline value - especially with regard to customised products. The terms for delay in delivery are defined by legal regulations. In any case, a writing notice issued by the purchaser is necessary for them to take effect.

### 7. Force Majeure (Act of God)

(1) SORG is not to be held responsible for the following delays of delivery. This also applies if these causes occur with respect to legal representatives, auxiliary persons, or deliverers of SORG: Circumstances of force majeure as well as other extraordinary events that are unpredictable and unavoidable for, and not caused by, SORG, and that only occur after ordering or reserving, and that SORG could not have known about. Moreover, this applies in case of strikes, fire, floods, labour disputes, business disruptions, altered magisterial approbation and legal situation, and magisterial orders which are not due to operational risks.

(2) In the cases of paragraph 1, SORG is eligible to delay delivery/performance for the time of hindrance as well as an appropriate start-up time. If SORG thus causes unacceptable complications for the purchaser, both SORG and the purchaser are eligible to withdraw from the contract. Circumstances that only lead to a temporal and hence acceptable delay of delivery and performance are excluded from this right. The legal rights of the client remain unaffected.

### 8. Dispatch

We generally dispatch uncovered by insurance and at the recipient's risk. We transfer the risk of coincidental loss or deterioration of the goods as well as delay on to the client at the moment of passing the goods on to the forwarder, bearer, or any other person/institute responsible for delivery. SORG will make any effort to respect the client's wishes in terms of path and kind of delivery. Any costs caused by this (including agreed carriage free delivery) are to be covered by the client. In the case of carriage free delivery conducted by SORG, the recipient is required to put forward any carriage costs for a refund. If the client wishes the dispatch to be delayed, any risk of loss or deterioration of the goods is carried by the recipient from the first day of readiness for dispatch. The goods dispatched are only insured upon special demand and at the cost of the recipient.

9. Damage through Delivery Angelieferte Gegenstände sind, auch wenn sie unwesentliche Mängel Upon delivery, the goods need to be checked for obvious damage in the presence of the bearer. Any damage is to be documented in a written form and co-signed by the bearer. This protocol is to be forwarded to us immediately. Delayed reclamations, or reclamations not signed by the bearer, cannot be taken into account.

### 10. Warranted Features, Receipt, and Technical Alterations

Delivered objects, even with minor damage, are to be accepted by the client, even if §433.paragraph 1 BGB is not fulfilled. Partial deliveries are permissible. Features only count as warranted if explicitly designated as such. A warranty of condition can only be asserted explicitly and in a written form. SORG reserves the right for technical alterations, especially for solutions of equal or higher value.

### 11. Warranty for Defects

(1) SORG warrants for any defects of delivered new goods for 12 months as long as the purchaser is not the user (§§ 474, 13 BGB). Should the purchaser be the user then the warranty period is two years for new goods, for used goods 12 months. Should the purchaser also be an entrepreneur, then the liability for used items is void, as long as there is no claim for compensation according to N° 12.

(2) The purchaser's claim for defects presuppose that he has attended his obligation to give notice of defects on the legal grounds for his reasons of inquiry (§§ 377, 381 HGB). If defects are found during the inspection or at a later point, we are to be notified in writing without delay. The notice counts as not delayed if issued within two weeks. Posting the notice on time suffices for the keeping of the term. Independently from this obligation to inspect and give notice, the purchaser is to report obvious defects (including wrong and short delivery) within two weeks upon delivery (again, posting

the notice on time suffices). If the purchaser misses the proper inspection and/or notice of defects, we do not warrant for the reported defects. If the delivered good is detected, we may choose to conduct supplementary performance either by repairing the defect (subsequent improvement) or by delivering flawless goods (compensation delivery). Our right to refuse the chosen method of supplementary performance on the respective legal grounds remains untouched.

(3) Our liability for defects expires when alteration or maintenance works are done by the client or a third-person-party without our prior written permission. Consequences of excessive strain, negligent or incorrect handling, and violent damage are excluded from the warranty for defects.

### 12. Further Liability

(1) With respect to compensation - regardless of the legal cause - SORG is only liable in case of malice and act of gross negligence. In case of slight negligence, SORG is only liable for damage of life, body, health, and for damage caused by the negligence of an essential contractual obligation (an obligation whose fulfilment make the proper realisation of the contract possible in the first place and in whose fulfilment the contract partner regularly trusts and can trust). In this case, however, our liability does not exceed the covering of predictable, typically occurring damage.

(2) A free right to termination on the part of the purchaser (acc. to § 651, 649 BGB in particular) is precluded. Otherwise, the usual prerequisites and legal consequences apply.

### 13. Costs of Supplementary Performance

Costs of supplementary performance cannot be charged on SORG's account.

### 14. Voluntary Withdrawal of Goods

SORG is not obliged to take back any delivered end products or parts thereof. If SORG voluntarily decides otherwise in individual cases (especially for therapeutically altered requirements or deaths), SORG refunds a maximum of 75% of the delivery costs for unused parts whose delivery does not date back more than three months. There is no legal obligation concerning withdrawal in this respect. Deliveries which date back more than three months as well as sewed parts and customised products are not returnable. A copy of the delivery note or the bill serves as proof of age of delivery.

### 15. Reservation of Ownership

Goods delivered by SORG remain the property of SORG until any obligations from the parties' business contract on the part of the purchaser have been redeemed. This also applies if SORG has adapted individual or all claims into a running account which has been balanced and acknowledged. The purchaser has the right to dispose of the goods in the proper course of business. The purchaser hereby yields all claims to SORG which arise from the resale against the purchaser or third parties. The purchaser is authorised to withdraw these claims even upon conveyance. SORG's right to withdraw the claims remains untouched. However, SORG is obliged not to withdraw the claims as long as the purchaser complies with his duty of payment and any other duties. SORG has the right to demand that the purchaser makes known the yielded claims and their debtors, that he provides all information necessary for conveyance, and that he hands in all associated documents. As long and insofar the reservation of ownership is intact, the purchaser must not transfer any goods for securing or bailment without SORG's permission. The purchaser may process or alter the goods for the benefit of SORG exclusively. If processed with other goods which do not belong to SORG, SORG obtains co-ownership of these new goods in relation to the invoice value to the cost price of the other processed goods. If a third party interferes with SORG's ownership, the purchaser is to notify SORG immediately. The purchaser must not make any agreements with other purchasers which may exclude or limit SORG's rights. In particular, the purchaser must not make any agreements which destroy or limit the advance assignments to SORG. If the estimated value of the existing guarantees exceeds the claims to be ensured by more than 20%, SORG is insofar obliged to release by request of the purchaser.

### 16. Copyright Protection

If SORG conveys any images, drawings, indications of weight or measurements, technical documentations, or other product descriptions and documents (including electronic ones), the respective indications only apply if explicitly stated that they do. SORG reserves ownership and copyright of all these documents. They may only be made available to third parties upon SORG's explicit permission.

### 17. Place of Fulfilment, Place of Jurisdiction, and Severability Clause

(1) The law of the Federal Republic of Germany applies for these Terms and Conditions and all legal relations between us and our business partners. All international and supranational (contractual) legal systems, the UN Convention on Contracts for the International Sale of Goods in particular, are hereby excluded. Prerequisites and effects of the reservation of ownership acc. to no. 15 are subject to the right of the respective storage location of the good if the choice of law made in favour of the German law is illegitimate or ineffective. The only place of jurisdiction (also on an international basis) for any disputes arising directly or indirectly from the contractual relationship is, according to German Commercial Code, our office in Oberhausen-Rheinhausen, Germany. However, we also have the right to file a suit concerning the general jurisdiction of the purchaser.

(2) If any clause in these Terms of Conditions should turn out to be ineffective, this does not affect the effectiveness of all other clauses.

Technical alterations and misprints reserved. As of: January 2017

SORG Rollstuhltechnik GmbH + Co. KG  
Benzstr. 3-5, 68794 Oberhausen-Rheinhausen / Germany  
Phone +49 7254 / 9279-0  
Fax +49 7254 / 9279-10  
info@sorgrollstuhltechnik.de, www.sorgrollstuhltechnik.de